



Since  
1992



**SPP**<sup>®</sup>  
SUBSTATION  
POWER PLANT  
PRODUCTS

**BİR-ER** ELEKTRİK SİSTEMLERİ YAPIM MÜHENDİSLİK SAN. ve TİC. LTD. ŞTİ.

[www.birerelektrik.com](http://www.birerelektrik.com)

## İÇİNDEKİLER / CONTENTS

<b>Topraklama / Earthing</b>	<b>3</b>
<b>İletken Bağlantıları / Conductor connections</b>	<b>11</b>
<b>Sıkıştırılmalı Tip Kablo Pabuçları &amp; Klemensleri</b> Crimping Type Copper Cable Terminal Lugs & Connectors	<b>21</b>
<b>Topraklama Kroşeleri / Grounding Clips</b>	<b>27</b>
<b>Kablo Kelepçeleri / Cable Cleats</b>	<b>31</b>
<b>Aydınlatma ve Yardımcı Elemanları / Lighting Fittings</b>	<b>37</b>
<b>Bara Tutucu / Bar Fixing</b>	<b>45</b>
<b>Uyarı - İsim Levhaları / Signs &amp; Chemicals</b>	<b>49</b>
<b>Havai Hat Malzemeleri / Overhead Line Terminals</b>	<b>53</b>
<b>Termo Kaynak Ürünler / Exothermic Welding</b>	<b>55</b>
<b>Civatalar/ Bolts</b>	<b>57</b>
<b>İletkenler / Conductors</b>	<b>61</b>
<b>Kalite Belgeleri / Our Certificates</b>	<b>65</b>



**BİR-ER** ELEKTRİK SİSTEMLERİ YAPIM MÜHENDİSLİK SAN. ve TİC. LTD. ŞTİ.



# TOPRAKLAMA

## EARTHING

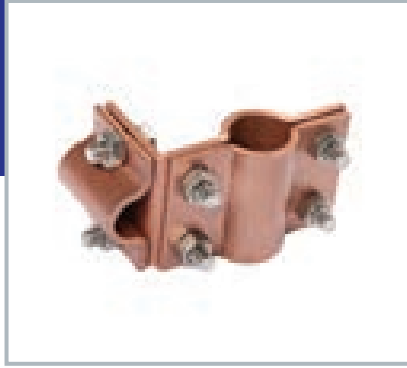

**BİR-ER** ELEKTRİK SİSTEMLERİ YAPIM MÜHENDİSLİK SAN. ve TİC. LTD. ŞTİ.

**BAKIR KAPLI ÇELİK TOPRAKLAMA ELEKTRODLARI / COPPERBOND STEEL EARTH RODS**



Sipariş Kodu Reference No.	Elektrod Ölçüsü Range-Earth Rod Ø (mm) L (mm)	Cu Kaplama Kalınlığı Cu Covered Thickness (mm)
TE-18-BK-1-1000	18 1000	1
TE-18-BK-1-1500	18 1500	1
TE-18-BK-1-2000	18 2000	1
TE-18-BK-1-2500	18 2500	1
TE-18-BK-1-3000	18 3000	1
TE-20-BK-1-1000	20 1000	1
TE-20-BK-1-1500	20 1500	1
TE-20-BK-1-2000	20 2000	1
TE-20-BK-1-2500	20 2500	1
TE-20-BK-1-3000	20 3000	1
TE-20-BK-2-1000	20 1000	2
TE-20-BK-2-1500	20 1500	2
TE-20-BK-2-2000	20 2000	2
TE-20-BK-2-2500	20 2500	2
TE-20-BK-2-3000	20 3000	2
TE-22-BK-3-2500	22 2500	3

**SOM BAKIR TOPRAKLAMA ELEKTRODLARI / SOLID COPPER EARTH RODS**



Sipariş Kodu Reference No.	Elektrod Ölçüsü Range-Earth Rod Ø (mm) L (mm)	Ağırlık Weight (kg)	Malzeme Material
TE-16-SB-1000	16 1000	1,792	SOLID COPPER
TE-16-SB-1500	16 1500	2,688	
TE-18-SB-1000	18 1000	2,268	
TE-18-SB-1500	18 1500	3,402	
TE-18-SB-2000	18 2000	4,536	
TE-18-SB-2500	18 2500	5,760	
TE-18-SB-3000	18 3000	6,804	
TE-20-SB-1000	20 1000	2,790	
TE-20-SB-1500	20 1500	4,185	
TE-20-SB-2000	20 2000	5,580	
TE-20-SB-2500	20 2500	6,975	
TE-20-SB-3000	20 3000	8,370	
TE-22-SB-2500	22 2500	8,470	

**TOPRAKLAMA ELEKTRODU ÇAKMA TAPASI / EARTH ROD DRIVING STUD**



Sipariş Kodu Reference No.	Elektrod Ölçüsü Range-Earth Rod Ø (mm)	Malzeme Material
TEÇ-18/20	18-20	STEEL
TEÇ-22	22	

**TOPRAKLAMA ELEKTRODU EKLEME MANŞONU / EARTH ROD COUPLING**

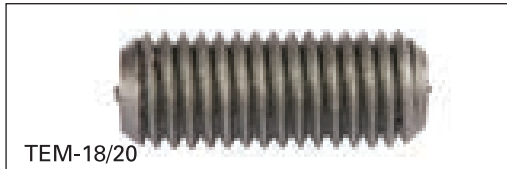

Sipariş Kodu Reference No.	Elektrod Ölçüsü Range-Earth Rod Ø (mm)	Ölçü Dimension mm	Malzeme Material
TEM-18/20	18-20	M12x70	STEEL
TEM-22	22	M12x70	

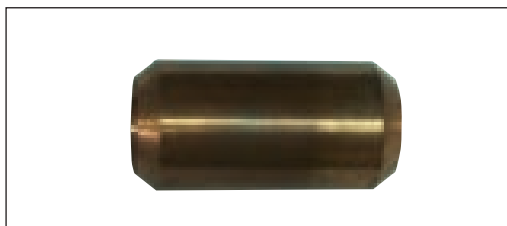

Sipariş Kodu Reference No.	Elektrod Ölçüsü Range-Earth Rod Ø (mm)	Ölçü Dimension mm	Malzeme Material
TEM-B-16	16	60	COPPER
TEM-B-18	18	60	
TEM-B-20	20	60	
TEM-B-22	22	60	

## TOPRAKLAMA ELEKTRODU SİVRİ UÇ / EARTH ROD SPIKE

Sipariş Kodu Reference No.	Elektrod Ölçüsü Range-Earth Rod Ø (mm)	Malzeme Material
TES-18/20	18-20	STEEL
TES-22	22	STEEL

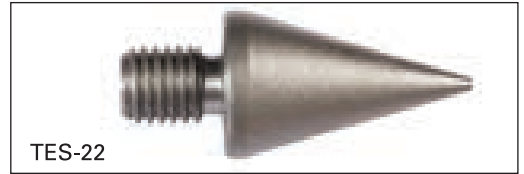

## GALVANİZLİ ÇELİK TOPRAKLAMA ELEKTRODLARI / H.D. GALVANIZED STEEL EARTH RODS

Sipariş Kodu Reference No.	Elektrod Ölçüsü Range-Earth Rod Ø (mm) L (mm)	Ağırlık Weight (kg)	Malzeme Material
TE-20-DG-1000	20 1000	2,600	H.D.G Steel
TE-20-DG-1500	20 1500	3,900	
TE-20-DG-2000	20 2000	5,100	



HDG: Hot Dip Galvanized Steel

## S.D.GALVANİZLİ ÇELİK TOPRAKLAMA ELEKTRODLARI / H.D.G.S. EARTH RODS ANGLE IRON

Sipariş Kodu Reference No.	Elektrod Ölçüsü Range-Earth Rod A (mm) t (mm)	Elektrod Boyu Earth Rod Length L (mm)	Ağırlık Weight (kg)	Malzeme Material
TE-50x5x1000	50x50 5	1000	3,900	H.D. GALVANIZED STEEL
TE-50x5x1500	50x50 5	1500	5,800	
TE-50x5x2000	50x50 5	2000	7,800	
TE-60x6x1000	60x60 6	1000	5,400	
TE-60x6x1500	60x60 6	1500	8,100	
TE-60x6x2000	60x60 6	2000	11,000	
TE-65x7x1000	65x65 7	1000	7,000	
TE-65x7x1500	65x65 7	1500	10,500	
TE-65x7x2000	65x65 7	2000	14,000	

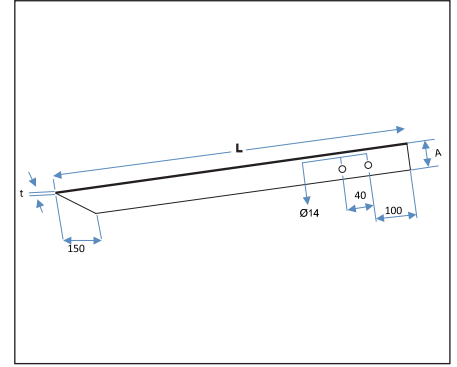

## TOPRAKLAMA LEVHASI / EARTH PLATES

Sipariş Kodu Reference No.	Ebatlar Dimensions (mm)	Ağırlık Weight (kg)	Malzeme Material
TL-1-B-700x700	700x700x1	4,360	COPPER
TL-1,5-B-700x700	700x700x1,5	6,540	COPPER
TL-2-B-700x700	700x700x2	8,720	COPPER
TL-3-B-700x700	700x700x3	13,080	COPPER
TL-1-B-1000x1000	1000x1000x1	8,920	COPPER
TL-2-B-1000x1000	1000x1000x2	17,840	COPPER
TL-1-B-1000x1000	1000x1000x3	26,760	COPPER
TL-2-G-400x1000	400x1000x2	6,500	H.D.GALVANIZED STEEL
TL-2-G-500x1000	500x1000x2	8,000	H.D.GALVANIZED STEEL
TL-2,5-G-500x1000	500x1000x2,5	10,000	H.D.GALVANIZED STEEL
TL-3-G-500x1000	500x1000x3	12,000	H.D.GALVANIZED STEEL

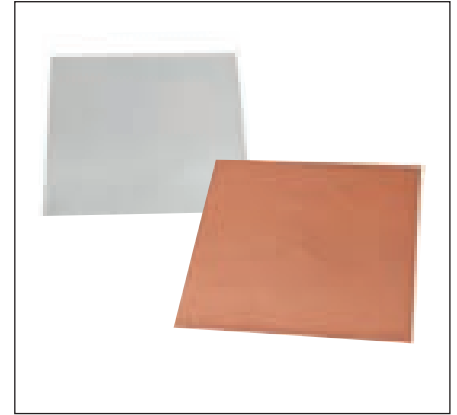

## TOPRAKLAMA ROGARI / EARTH PITS

Sipariş Kodu Reference No.	Ebatları Size (mm)	Malzeme Material
TR-400-G	400x400x400	HOT DIP GALVANIZED STEEL
TR-500-G	500x500x500	HOT DIP GALVANIZED STEEL



## TOPRAK ZEMİN İYİLEŞTİRME / EARTH GROUND IMPROVEMENT



Sipariş Kodu Reference No.	Açıklama Characteristics	Ağırlık Weight (kg)
EGI-12	Toprak iletkenliğini artırıcı toz / Earth conductivity improver powder	12

## EŞ POTANSİYEL BARA / EQUIPOTENTIAL BONDING

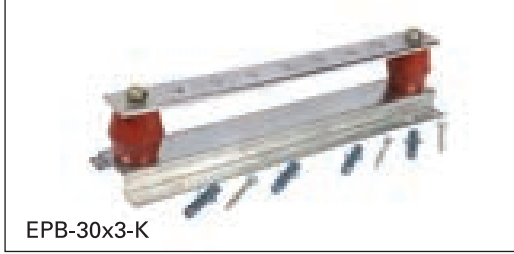

Sipariş Kodu Reference No.	Lama Ölçüsü Range - Tape (mm)	Uzunluk Length Size (mm)	Malzeme Material
EPB-30x3-B	30x3	300	E-Cu
EPB-30x5-B	30x5	300	
EPB-40x5-B	40x5	500	
EPB-50x5-B	50x5	500	
EPB-60x5-B	60x5	500	

DELİK ÇAPI VE DİĞER ÖLÇÜLER İÇİN İRTİBATA GEÇİNİZ. / FOR OTHER SIZES PLEASE CONTACT US.

B : BAKIR (KAPLAMASIZ) / SOLID COPPER

K : KALAY KAPLI BAKIR / TIN PLATED COPPER

N : NİKEL KAPLI BAKIR / NICKEL PLATED COPPER

G : SICAK DALDIRMA GALVANİZLİ ÇELİK LAMA / HOT DIP GALVANIZED STEEL

## EŞ POTANSİYEL BARA (AYIRICILI) / EQUIPOTENTIAL BONDING (DISCONNECTING)



Sipariş Kodu Reference No.	Lama Ölçüsü Range - Tape (mm)	Uzunluk Length Size (mm)	Malzeme Material
AEPB-40x5-B	40x5	500	E-Cu
AEPB-50x5-B	50x5	500	

DELİK ÇAPI VE DİĞER ÖLÇÜLER İÇİN İRTİBATA GEÇİNİZ. / FOR OTHER SIZES PLEASE CONTACT US.

B : BAKIR (KAPLAMASIZ) / COPPER (UNCOATED)

K : KALAY KAPLI BAKIR / TIN PLATED COPPER

N : NİKEL KAPLI BAKIR / NICKEL PLATED COPPER

G : SICAK DALDIRMA GALVANİZLİ ÇELİK LAMA / HOT DIP GALVANIZED STEEL

## NÖTR TOPRAKLAMA BARASI / NOTR BAR

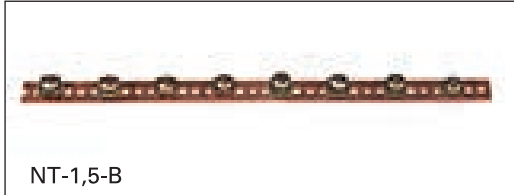

Sipariş Kodu Reference No.	Lama Ölçüsü Thickness (mm)	Uzunluk Length Size (mm)	Malzeme Material
NT-1,5-B	1.5	1000	E-Cu
NT-2-B	2	1000	
NT-3-B	3	1000	

## FENS LAMASI / COPPER TAPE FOR FENCE

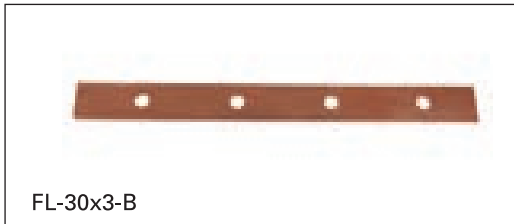

Sipariş Kodu Reference No.	Ebatları Dimensions (mm)	Uzunluk Length Size (mm)	Malzeme Material
FL-30x3-B	30X3	300	E-Cu
FL-30x5-B	30X5	300	
FL-40x3-B	40X3	300	
FL-40x5-B	40X5	300	

## TOPRAKLAMA PRİZİ / EARTH POINTS

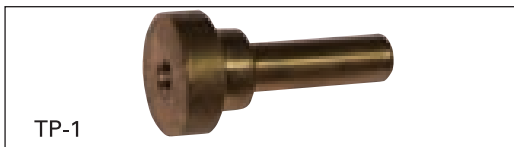

Sipariş Kodu Reference No.	Civata Ölçüsü Bolt Dimensions (mm)	Boyut Size (mm)	Malzeme Material
TP-1	M8x15	Ø12x60	NAVAL BRASS

## TOPRAKLAMA TAKOZU / GROUNDING BLOCK



Sipariş Kodu Reference No.	Civata Ölçüsü Bolt Dimension (mm)	Boyut Size (mm)	Malzeme Material
TT-30	M8x20	Ø30x35	GALV. STEEL

## FLEXIBLE ÖRGÜLÜ BAKIR İLETKEN / FLEXIBLE COPPER BRAID CONDUCTORS

Sipariş Kodu Reference No.	İletken Kesiti Conductor Range (mm <sup>2</sup> )	Ölçü / Dimensions (mm)			
		A	N	L	d
FC 10-150		17	10	150	8.5
FC 10-200	10	17	10	200	8.5
FC 10-250		17	10	250	8.5
FC 16-150		17	10	150	8.5
FC 16-200	16	17	10	200	8.5
FC 16-250		17	10	250	8.5
FC 25-150		21	10	150	8.5
FC 25-200	25	21	10	200	8.5
FC 25-250		21	10	250	8.5

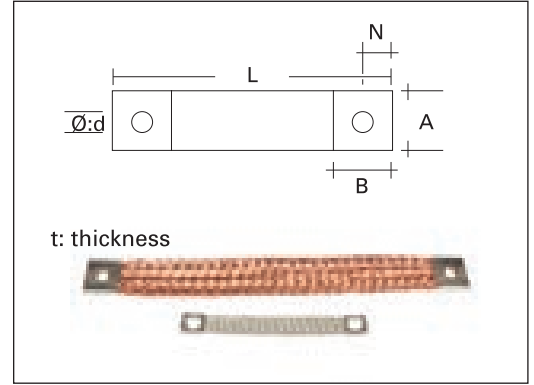

ENxBOY, KESİT ve DELİK ÖLÇÜSÜ BİLDİRİNİZ./ FOR HOLE DIAMETER AND OTHER SIZES PLEASE CONTACT US.  
K : KALAY KAPLI / TIN PLATED B : BAKIR (KAPLAMASIZ) / COPPER (UNCOATED)

## FLEXIBLE ÖRGÜLÜ BAKIR İLETKEN / FLEXIBLE COPPER BRAID CONDUCTORS

Sipariş Kodu Reference No.	Ölçü / Dimensions (mm)					Malzeme Material
	A	B	N	L	d	
FÖBİ-B						COPPER
FÖBİ-K						TIN PLATED COPPER
FÖBİ-G						SILVER PLATED COPPER

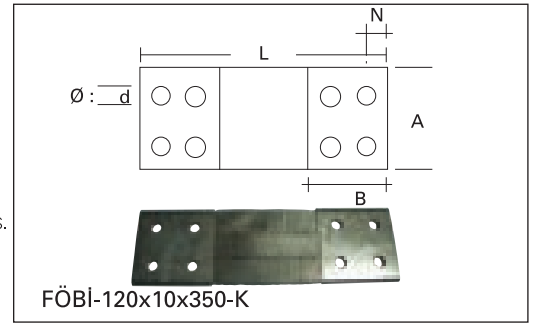

ENxBOY, KESİT ve DELİK ÖLÇÜSÜ BİLDİRİNİZ./FOR HOLE DIAMETER AND OTHER SIZES PLEASE CONTACT US.  
K : KALAY KAPLI / TIN PLATED  
B : BAKIR (KAPLAMASIZ) / COPPER (UNCOATED)  
G : GÜMÜŞ KAPLAMALI / SILVER PLATED

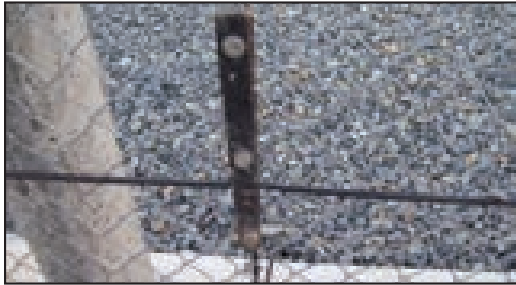

(application) FL-30x3-B

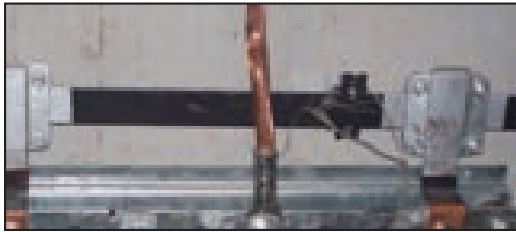

(application) EPB-40x5x500-K

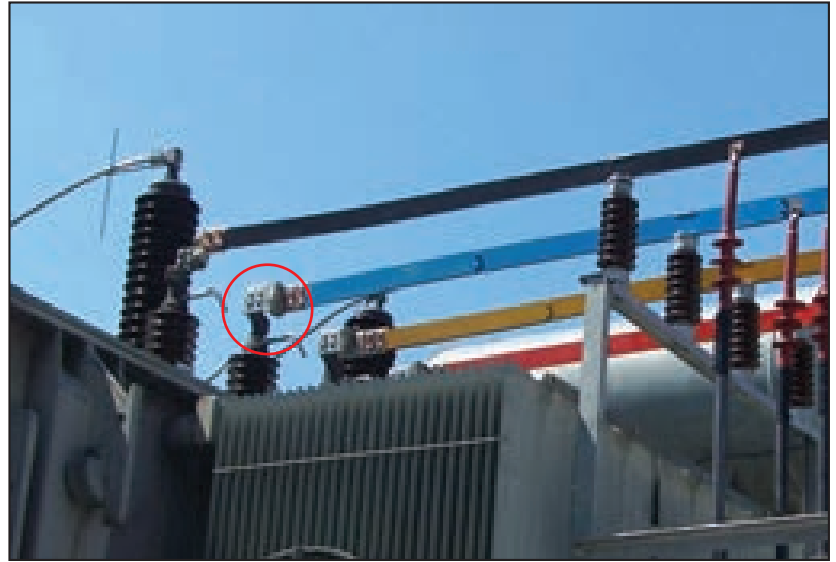

(application) FÖBİ-K 2x(120x10x350)

## Bİ-METAL PUL(Alüminyum-Bakır Kaplı) / BIMETALLIC WASHER(Aluminium inside/Copper outside)

Sipariş Kodu Reference No.	Pul Washer (mm)	Malzeme Material
BP-8	M.8	COPPER COATED ALUMINIUM
BP-10	M.10	
BP-12	M.12	

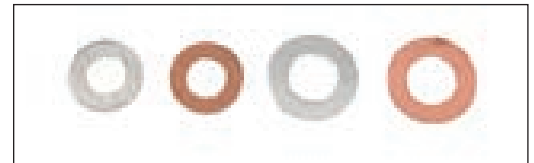

## Bİ-METAL LEVHA(Alüminyum-Bakır Kaplı) / BIMETALLIC PLATES(Aluminium inside/Copper outside)

Sipariş Kodu Reference No.	Ölçü Dimensions AxBxt (mm)	Malzeme Material
BL-A-B-1	Ölçü bildiriniz	SINGLE COATED COPPER SURFACE



ÖLÇÜ BİLDİRİNİZ. / PLEASE SPECIFY THE SIZE.



**Bİ-METAL LEVHA (Bakır-Gümüş Kaplı) / BIMETALLIC PLATES (Copper inside-Silver outside)**

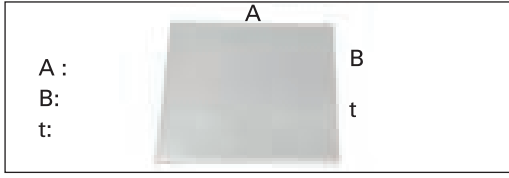

Sipariş Kodu Reference No.	Ölçü Dimensions AxBxt (mm)	Malzeme Material
BL-B-G-1	Ölçü bildiriniz	SINGLE SURFACE COATED SILVER PLATE
BL-B-G-2	Ölçü bildiriniz	DOUBLE COATED SILVER PLATE

ÖLÇÜ BİLDİRİNİZ. / PLEASE SPECIFY THE SIZE.

**ELEKTROD BAŞLIĞI İLETKEN İÇİN / ROD TO CABLE CLAMP**



Sipariş Kodu Reference No.	Elektrod Çapı Range-Earth Rod Ø (mm)	İletken Kesiti Conductor Range (mm <sup>2</sup> )	Malzeme Material
EB-18-B-25	18	1x25	E-Cu
EB-18-B-35	18	1x35	
EB-18-B-50	18	1x50	
EB-18-B-70	18	1x70	



Sipariş Kodu Reference No.	Elektrod Çapı Range-Earth Rod Ø (mm)	İletken Kesiti Conductor Range (mm <sup>2</sup> )	Malzeme Material
EB-18-B-95	18	1x95	E-Cu
EB-18-B-120	18	1x120	
EB-18-B-150	18	1x150	
EB-20-B-25	20	1x25	
EB-20-B-35	20	1x35	
EB-20-B-50	20	1x50	
EB-20-B-70	20	1x70	
EB-20-B-95	20	1x95	
EB-20-B-120	20	1x120	
EB-20-B-150	20	1x150	
EB-20-B-185	20	1x185	
EB-20-B-240	20	1x240	
EB-22-B-25	22	1x25	
EB-22-B-35	22	1x35	
EB-22-B-50	22	1x50	
EB-22-B-70	22	1x70	
EB-22-B-95	22	1x95	
EB-22-B-120	22	1x120	
EB-22-B-150	22	1x150	
EB-22-B-185	22	1x185	
EB-22-B-240	22	1x240	

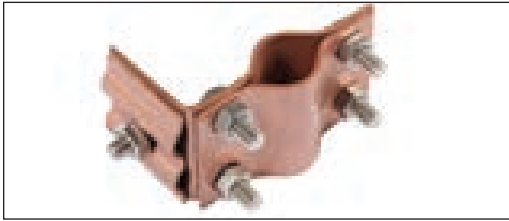

Sipariş Kodu Reference No.	Elektrod Çapı Range-Earth Rod Ø (mm)	İletken Kesiti Conductor Range (mm <sup>2</sup> )	Malzeme Material
EB-18-B-2x25	18	2x25	E-Cu
EB-18-B-2x35	18	2x35	
EB-18-B-2x50	18	2x50	
EB-18-B-2x70	18	2x70	



Sipariş Kodu Reference No.	Elektrod Çapı Range-Earth Rod Ø (mm)	İletken Kesiti Conductor Range (mm <sup>2</sup> )	Malzeme Material
EB-18-B-2x95	18	2x95	E-Cu
EB-18-B-2x120	18	2x120	
EB-18-B-2x150	18	2x150	
EB-20-B-2x25	20	2x25	
EB-20-B-2x35	20	2x35	
EB-20-B-2x50	20	2x50	
EB-20-B-2x70	20	2x70	
EB-20-B-2x95	20	2x95	
EB-20-B-2x120	20	2x120	
EB-20-B-2x150	20	2x150	
EB-22-B-2x185	22	2x95	
EB-22-B-2x240	22	2x120	

Bolts : Inox A2-70

**TOPRAKLAMA ELEKTROD BAŞLIĞI / ROD TO TAPE CLAMP**

üç parçalı / three-piece

Sipariş Kodu Reference No.	Elektrod Çapı Range-Earth Rod Ø (mm) Cu	Lama Ölçüsü Copper Tape (mm)	Malzeme Material
EB-18-B-20x3	18	20x3	E-Cu
EB-18-B-20x5	18	20x5	
EB-18-B-25x3	18	25x3	
EB-18-B-30x3	18	30x3	
EB-18-B-30x5	18	30x5	
EB-18-B-40x3	18	40x3	
EB-18-B-40x4	18	40x4	
EB-18-B-40x5	18	40x5	
EB-18-B-50x3	18	50x3	
EB-18-B-50x5	18	50x5	
EB-20-B-20x3	20	20x3	
EB-20-B-20x5	20	20x5	
EB-20-B-25x3	20	25x3	
EB-20-B-30x3	20	30x3	
EB-20-B-30x5	20	30x5	
EB-20-B-40x3	20	40x3	
EB-20-B-40x4	20	40x4	
EB-20-B-40x5	20	40x5	
EB-20-B-50x3	20	50x3	
EB-20-B-50x5	20	50x5	
EB-22-B-20x3	22	20x3	
EB-22-B-20x5	22	20x5	
EB-22-B-25x3	22	25x3	
EB-22-B-30x3	22	30x3	
EB-22-B-30x5	22	30x5	
EB-22-B-40x3	22	40x3	
EB-22-B-40x4	22	40x4	
EB-22-B-40x5	22	40x5	
EB-22-B-50x3	22	50x3	
EB-22-B-50x5	22	50x5	
EB-22-B-60x4	22	60x4	
EB-22-B-60x5	22	60x5	



dört parçalı / four-piece

Sipariş Kodu Reference No.	Elektrod Çapı Range-Earth Rod Ø (mm) HDG.S	Lama Ölçüsü Galvanized Tape (mm)	Malzeme Material
EB-18-G-20x3	18	20x3	H.D.G. Steel
EB-18-G-20x5	18	20x5	
EB-18-G-25x3	18	25x3	
EB-18-G-30x3	18	30x3	
EB-18-G-30x5	18	30x5	
EB-18-G-40x3	18	40x3	
EB-18-G-40x4	18	40x4	
EB-18-G-40x5	18	40x5	
EB-18-G-50x3	18	50x3	
EB-18-G-50x5	18	50x5	
EB-20-G-20x3	20	20x3	
EB-20-G-20x5	20	20x5	
EB-20-G-25x3	20	25x3	
EB-20-G-30x3	20	30x3	
EB-20-G-30x5	20	30x5	
EB-20-G-40x3	20	40x3	
EB-20-G-40x4	20	40x4	
EB-20-G-40x5	20	40x5	
EB-20-G-50x3	20	50x3	
EB-20-G-50x5	20	50x5	



**TOPRAKLAMA ELEKTROD BAŞLIĞI / ROD TO TAPE CLAMP**

dört parçalı / four-piece

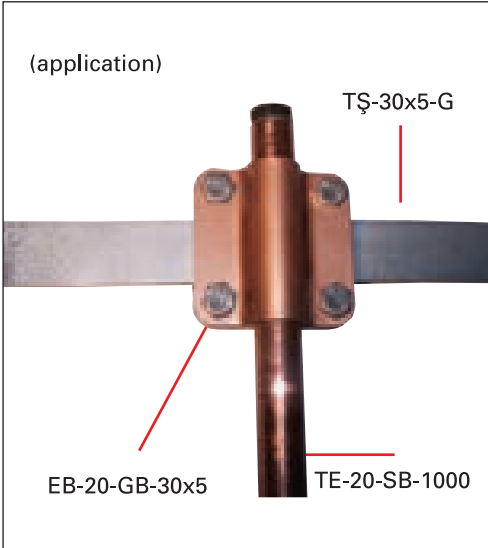

Sipariş Kodu Reference No.	Elektrod Çapı Range-Earth Rod Ø (mm) Cu	Lama Ölçüsü Galvanized Tape (mm)	Malzeme Material
EB-18-GB-20x3	18	20x3	E-Cu + H.D.G. Steel
EB-18-GB-20x5	18	20x5	
EB-18-GB-25x3	18	25x3	
EB-18-GB-30x3	18	30x3	
EB-18-GB-30x5	18	30x5	
EB-18-GB-40x3	18	40x3	
EB-18-GB-40x4	18	40x4	
EB-18-GB-40x5	18	40x5	
EB-18-GB-50x3	18	50x3	
EB-18-GB-50x5	18	50x5	
EB-20-GB-20x3	20	20x3	
EB-20-GB-20x5	20	20x5	
EB-20-GB-25x3	20	25x3	
EB-20-GB-30x3	20	30x3	
EB-20-GB-30x5	20	30x5	
EB-20-GB-40x3	20	40x3	
EB-20-GB-40x4	20	40x4	
EB-20-GB-40x5	20	40x5	
EB-20-GB-50x3	20	50x3	
EB-20-GB-50x5	20	50x5	
EB-22-GB-20x3	22	20x3	
EB-22-GB-20x5	22	20x5	
EB-22-GB-25x3	22	25x3	
EB-22-GB-30x3	22	30x3	
EB-22-GB-30x5	22	30x5	
EB-22-GB-40x3	22	40x3	
EB-22-GB-40x4	22	40x4	
EB-22-GB-40x5	22	40x5	
EB-22-GB-50x3	22	50x3	
EB-22-GB-50x5	22	50x5	
EB-22-GB-60x4	22	60x4	
EB-22-GB-60x5	22	60x5	

H.D.G. Steel : Hot Dip Galvanized Steel

Bolts : Inox A2-70

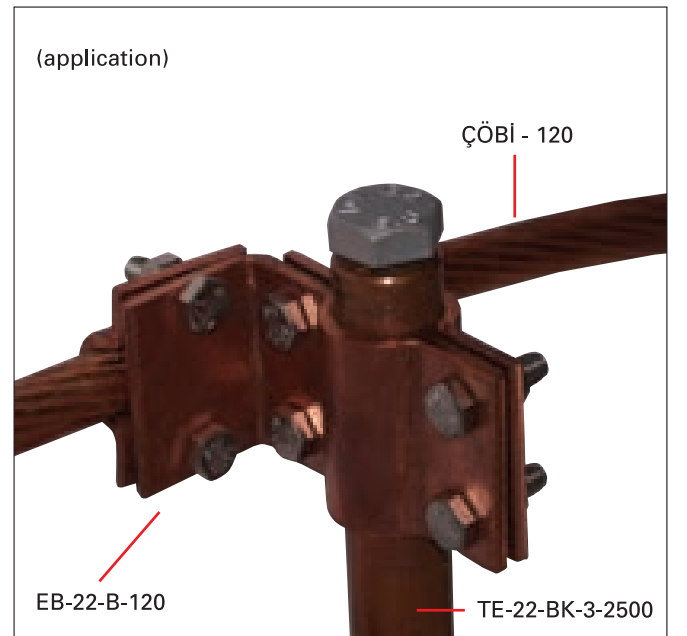
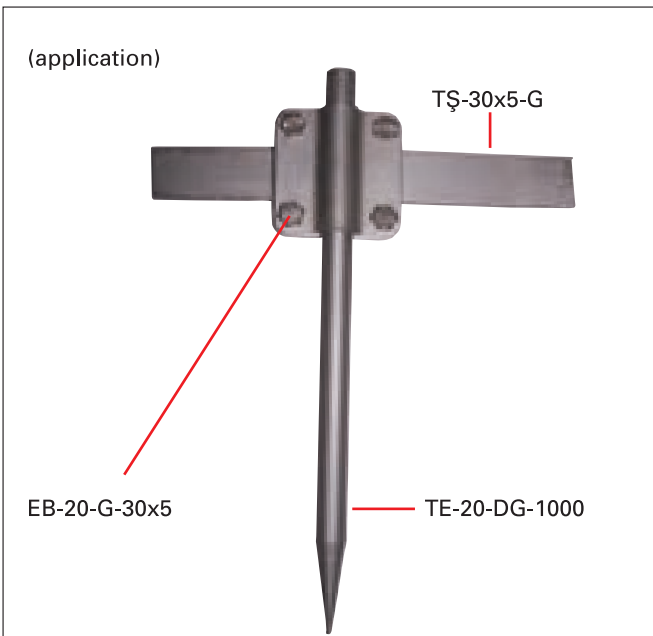

# İLETKEN BAĞLANTILARI

## CONDUCTOR CONNECTIONS

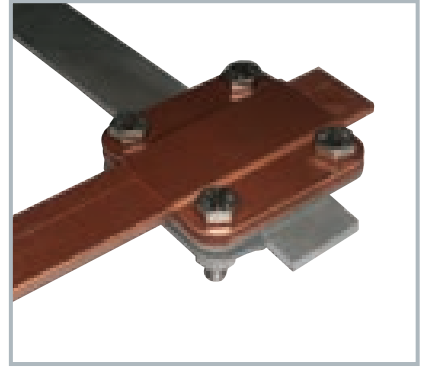
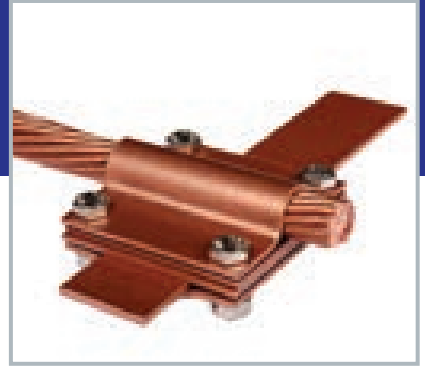

**BİR-ER** ELEKTRİK SİSTEMLERİ YAPIM MÜHENDİSLİK SAN. ve TİC. LTD. ŞTİ.

### KIZIL KLEMENS / NAVAL BRASS CLAMP

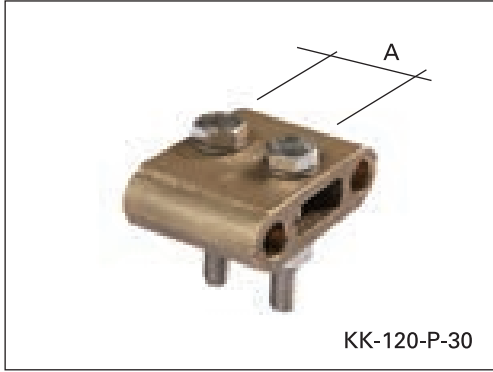

Sipariş Kodu Reference No.	Delikler Arası Mesafe Hole Size A(mm)	İletken Kesiti Conductor Range (mm <sup>2</sup> )	Malzeme Material
KK-50-P-30	30	50	NAVAL BRASS
KK-50-P-35	35	50	
KK-70-P-30	30	70	
KK-70-P-35	35	70	
KK-95-P-30	30	95	
KK-95-P-35	35	95	
KK-95-P-45	45	95	
KK-95-P-60	60	95	
KK-120-P-30	30	120	
KK-120-P-35	35	120	
KK-120-P-45	45	120	
KK-120-P-60	60	120	
KK-150-P-30	30	150	
KK-150-P-35	35	150	
KK-150-P-45	45	150	
KK-150-P-60	60	150	
KK-185-P-30	30	185	
KK-185-P-35	35	185	
KK-185-P-45	45	185	
KK-185-P-60	60	185	
KK-240-P-30	30	240	
KK-240-P-35	35	240	
KK-240-P-45	45	240	
KK-240-P-60	60	240	

Bolts:Inox A2 70 M10x60

SINGLE

### PİRİNÇ PARALEL KLEMENS / NAVAL BRASS PARALLEL CLAMP



Sipariş Kodu Reference No.	İletken Kesiti Conductor Range (mm <sup>2</sup> )	Malzeme Material
NBC-1	50-150	NAVAL BRASS

Bolts:M12x50 INOX A2 70

SINGLE

### PİRİNÇ PARALEL KLEMENS / NAVAL BRASS PARALLEL CLAMP



Sipariş Kodu Reference No.	İletken Kesiti Conductor Range (mm <sup>2</sup> )	Malzeme Material
NBC-2	50-150	NAVAL BRASS

Bolts:M12x65 INOX A2 70

### Al-Cu KLEMENS / Al - Cu CLAMP



Sipariş Kodu Reference No.	İletken Kesiti Conductor Range Al. (mm <sup>2</sup> )	İletken Kesiti Conductor Range Cu. (mm <sup>2</sup> )	Malzeme Material
KBA-25-A-16	25	16	ALUMINIUM
KBA-50-A-25	50	25	
KBA-70-A-50	70	50	
KBA-120-A-70	120	70	
KBA-240-A-120	240	120	

Bolts:Property Class 8.8

**TIRNAKLI KLEMENS / CLAW COUPLING CLAMP**

Sipariş Kodu Reference No.	İletken Kesiti Conductor Range (mm <sup>2</sup> )	İletken Kesiti Conductor Range (mm <sup>2</sup> )	Malzeme Material
KTP-10	10	10	NAVAL BRASS
KTP-16	16	16	
KTP-25	25	25	
KTP-35	35	35	
KTP-50	50	50	
KTP-70	70	70	
KTP-95	95	95	
KTP-120	120	120	



Bolts: Property Class : 8.8 Electro Galvanized

**DAĞITIM KLEMENSİ İLETKEN TİP (Düz, T, L, + Tip) / DISTRIBUTION CABLE CLAMP (Lineal, in T, in L, in cross)**

**üç parçalı / three-piece**

Sipariş Kodu Reference No.	İletken Kesiti Conductor Range (mm <sup>2</sup> )	İletken Kesiti Conductor Range (mm <sup>2</sup> )	Malzeme Material
DKI-50-B-50	50	50	E-Cu
DKI-50-B-70	50	70	
DKI-50-B-95	50	95	
DKI-50-B-120	50	120	
DKI-50-B-150	50	150	
DKI-50-B-185	50	185	
DKI-50-B-240	50	240	
DKI-70-B-70	70	70	
DKI-70-B-95	70	95	
DKI-70-B-120	70	120	
DKI-70-B-150	70	150	
DKI-70-B-185	70	185	
DKI-70-B-240	70	240	
DKI-95-B-95	95	95	
DKI-95-B-120	95	120	
DKI-95-B-150	95	150	
DKI-95-B-185	95	185	
DKI-95-B-240	95	240	
DKI-120-B-120	120	120	
DKI-120-B-150	120	150	
DKI-120-B-185	120	185	
DKI-120-B-240	120	240	
DKI-150-B-150	150	150	
DKI-150-B-185	150	185	
DKI-150-B-240	150	240	
DKI-185-B-185	185	185	
DKI-185-B-240	185	240	
DKI-240-B-240	240	240	



**DAĞITIM KLEMENSİ İLETKEN TİP (Düz, T, L, + Tip) / DISTRIBUTION CABLE CLAMP (Lineal, in T, in L, in cross)**

**üç parçalı / three-piece**



DKI-50-G-50	50	50	H.D.G. Steel
DKI-50-G-70	50	70	
DKI-50-G-95	50	95	
DKI-50-G-120	50	120	
DKI-50-G-150	50	150	
DKI-70-G-50	70	50	
DKI-70-G-70	70	70	
DKI-70-G-95	70	95	
DKI-70-G-120	70	120	
DKI-70-G-150	70	150	
DKI-95-G-50	95	50	
DKI-95-G-70	95	70	
DKI-95-G-95	95	95	
DKI-95-G-120	95	120	
DKI-95-G-150	95	150	
DKI-120-G-50	120	50	
DKI-120-G-70	120	70	
DKI-120-G-95	120	95	
DKI-120-G-120	120	120	
DKI-120-G-150	120	150	
DKI-150-G-50	150	50	
DKI-150-G-70	150	70	
DKI-150-G-95	150	95	
DKI-150-G-120	150	120	
DKI-150-G-150	150	150	

H.D.G. Steel : Hot Dip Galvanized Steel

Bolts : Inox A2-70

**DAĞITIM KLEMENSİ İLETKEN TİP (Düz, T, L, + Tip) / DISTRIBUTION CABLE CLAMP (Lineal, in T, in L, in cross)**

**iki parçalı / two-piece**



Sipariş Kodu Reference No.	İletken Kesiti Conductor Range (mm <sup>2</sup> )	İletken Kesiti Conductor Range (mm <sup>2</sup> )	Malzeme Material
DKT-50-B-50	50	50	E-Cu
DKT-50-B-70	50	70	
DKT-50-B-95	50	95	
DKT-50-B-120	50	120	
DKT-50-B-150	50	150	
DKT-70-B-50	70	50	
DKT-70-B-70	70	70	
DKT-70-B-95	70	95	
DKT-70-B-120	70	120	
DKT-70-B-150	70	150	
DKT-95-B-50	95	50	
DKT-95-B-70	95	70	
DKT-95-B-95	95	95	
DKT-95-B-120	95	120	
DKT-95-B-150	95	150	
DKT-120-B-50	120	50	
DKT-120-B-70	120	70	
DKT-120-B-95	120	95	
DKT-120-B-120	120	120	
DKT-120-B-150	120	150	
DKT-150-B-50	150	50	
DKT-150-B-70	150	70	
DKT-150-B-95	150	95	
DKT-150-B-120	150	120	
DKT-150-B-150	150	150	

**DAĞITIM KLEMENSİ İLETKEN TİP (Düz, T, L, + Tip) / DISTRIBUTION CABLE CLAMP (Lineal, in T, in L, in cross)**

iki parçalı / two-piece

Sipariş Kodu Reference No.	İletken Kesiti Conductor Range (mm <sup>2</sup> )	İletken Kesiti Conductor Range (mm <sup>2</sup> )	Malzeme Material
DKT-50-G-50	50	50	H.D.G. Steel
DKT-50-G-70	50	70	
DKT-50-G-95	50	95	
DKT-50-G-120	50	120	
DKT-50-G-150	50	150	
DKT-70-G-50	70	50	
DKT-70-G-70	70	70	
DKT-70-G-95	70	95	
DKT-70-G-120	70	120	
DKT-70-G-150	70	150	
DKT-95-G-50	95	50	
DKT-95-G-70	95	70	
DKT-95-G-95	95	95	
DKT-95-G-120	95	120	
DKT-95-G-150	95	150	
DKT-120-G-50	120	50	
DKT-120-G-70	120	70	
DKT-120-G-95	120	95	
DKT-120-G-120	120	120	
DKT-120-G-150	120	150	
DKT-150-G-50	150	50	
DKT-150-G-70	150	70	
DKT-150-G-95	150	95	
DKT-150-G-120	150	120	
DKT-150-G-150	150	150	



H.D.G. Steel : Hot Dip Galvanized Steel

Bolts : Inox A2-70

**DAĞITIM KLEMENSİ (+) MODELİ / DISTRIBUTION CLAMP (+) MODEL**

iki parçalı / two-piece

Sipariş Kodu Reference No.	İletken Kesiti Conductor Range (mm <sup>2</sup> )	İletken Kesiti Conductor Range (mm <sup>2</sup> )	Malzeme Material
DK(+)-50-B-50	50	50	E-Cu
DK(+)-70-B-70	70	70	
DK(+)-95-B-95	95	95	
DK(+)-120-B-120	120	120	
DK(+)-150-B-150	150	150	



Sipariş Kodu Reference No.	İletken Kesiti Conductor Range (mm <sup>2</sup> )	İletken Kesiti Conductor Range (mm <sup>2</sup> )	Malzeme Material
DK(+)-50-G-50	50	50	H.D.G. Steel
DK(+)-70-G-70	70	70	
DK(+)-95-G-95	95	95	
DK(+)-120-G-120	120	120	
DK(+)-120-G-150	150	150	



H.D.G. Steel : Hot Dip Galvanized Steel

Bolts : Inox A2-70

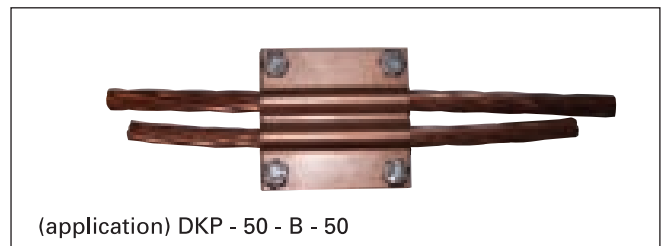
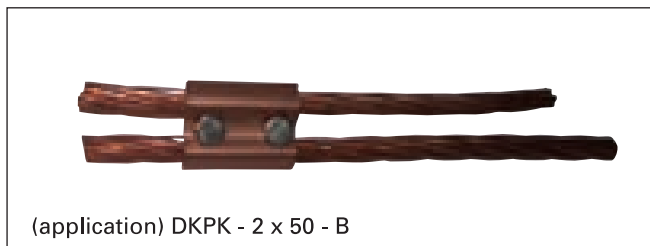



## DAĞITIM KLEMENSİ PARALEL TİP / DISTRIBUTION CLAMP - PARALLEL MODEL

iki parçalı / two-piece



Sipariş Kodu Reference No.	İletken Kesiti Conductor Range (mm <sup>2</sup> )	İletken Kesiti Conductor Range (mm <sup>2</sup> )	Malzeme Material
DKP-50-B-50	50	50	E-Cu
DKP-70-B-70	70	70	
DKP-95-B-95	95	95	
DKP-150-B-120	120	120	
DKP-150-B-150	150	150	

## DAĞITIM KLEMENSİ PARALEL KÜÇÜK MODEL / DISTRIBUTION CLAMP - PARALLEL MODEL SMALL



Sipariş Kodu Reference No.	İletken Kesiti Conductor Range (mm <sup>2</sup> )	İletken Kesiti Conductor Range (mm <sup>2</sup> )	Malzeme Material
DKPK-2x16-B	16	16	E-Cu
DKPK-2x25-B	25	25	
DKPK-2x35-B	35	35	
DKPK-2x50-B	50	50	
DKPK-2x70-B	70	70	

E-Cu: Electrolytic Copper

H.D.G. Steel : Hot Dip Galvanized Steel

Bolts : Inox A2-70

## DAĞITIM KLEMENSİ LAMA TİP / DISTRIBUTION CLAMP - STRIP MODEL

COPPER TAPE - COPPER TAPE

üç parçalı / three-piece



Sipariş Kodu Reference No.	Lama Ölçüsü Copper Tape (mm)	Lama Ölçüsü Copper Tape (mm)	Malzeme Material
DKL-30x3-B-30x3	30x3	30x3	E-Cu
DKL-30x3-B-30x5	30x3	30x5	
DKL-30x3-B-40x3	30x3	40x3	
DKL-30x3-B-40x4	30x3	40x4	
DKL-30x3-B-40x5	30x3	40x5	
DKL-30x3-B-50x3	30x3	50x3	
DKL-30x3-B-50x5	30x3	50x5	
DKL-30x5-B-30x5	30x5	30x5	
DKL-30x5-B-40x3	30x5	40x3	
DKL-30x5-B-40x4	30x5	40x4	
DKL-30x5-B-40x5	30x5	40x5	
DKL-30x5-B-50x3	30x5	50x3	
DKL-30x5-B-50x5	30x5	50x5	
DKL-40x3-B-40x3	40x3	40x3	
DKL-40x3-B-40x4	40x3	40x4	
DKL-40x3-B-40x5	40x3	40x5	
DKL-40x3-B-50x3	40x3	50x3	
DKL-40x3-B-50x5	40x3	50x5	
DKL-40x4-B-40x4	40x4	40x4	
DKL-40x4-B-40x5	40x4	40x5	
DKL-40x4-B-50x3	40x4	50x3	
DKL-40x4-B-50x5	40x4	50x5	
DKL-40x5-B-40x5	40x5	40x5	
DKL-40x5-B-50x3	40x5	50x3	
DKL-40x5-B-50x5	40x5	50x5	
DKL-50x3-B-50x3	50x3	50x3	
DKL-50x3-B-50x5	50x5	50x5	
DKL-60x4-B-60x4	60x4	60x4	
DKL-60x5-B-60x5	60x5	60x5	

E-Cu: Electrolytic Copper

H.D.G. Steel : Hot Dip Galvanized Steel

Bolts : Inox A2-70

**DAĞITIM KLEMENSİ LAMA TİP / DISTRIBUTION CLAMP - STRIP MODEL**

**COPPER TAPE -GALVANIZED STEEL TAPE**

**dört parçalı / four-piece**

Sipariş Kodu Reference No.	Lama Ölçüsü Copper Tape (mm)	Lama Ölçüsü Galvanized Tape (mm)	Malzeme Material
DKL-30x3-B-30x3-G	30x3	30x3	E-Cu+H.D.G.S
DKL-30x3-B-30x5-G	30x3	30x5	
DKL-30x3-B-40x3-G	30x3	40x3	
DKL-30x3-B-40x4-G	30x3	40x4	
DKL-30x3-B-40x5-G	30x3	40x5	
DKL-30x3-B-50x3-G	30x3	50x3	
DKL-30x3-B-50x5-G	30x3	50x5	
DKL-30x5-B-30x5-G	30x5	30x5	
DKL-30x5-B-40x3-G	30x5	40x3	
DKL-30x5-B-40x4-G	30x5	40x4	
DKL-30x5-B-40x5-G	30x5	40x5	
DKL-30x5-B-50x3-G	30x5	50x3	
DKL-30x5-B-50x5-G	30x5	50x5	
DKL-40x3-B-40x3-G	40x3	40x3	
DKL-40x3-B-40x4-G	40x3	40x4	
DKL-40x3-B-40x5-G	40x3	40x5	
DKL-40x3-B-50x3-G	40x3	50x3	
DKL-40x3-B-50x5-G	40x3	50x5	
DKL-40x4-B-40x4-G	40x4	40x4	
DKL-40x4-B-40x5-G	40x4	40x5	
DKL-40x4-B-50x3-G	40x4	50x3	
DKL-40x4-B-50x5-G	40x4	50x5	
DKL-40x5-B-40x5-G	40x5	40x5	
DKL-40x5-B-50x3-G	40x5	50x3	
DKL-40x5-B-50x5-G	40x5	50x5	
DKL-50x3-B-50x3-G	50x3	50x3	
DKL-50x3-B-50x5-G	50x5	50x5	



**E-Cu:** Electrolytic Copper

**H.D.G.S :** Hot Dip Galvanized Steel

**Bolts :** Inox A2-70

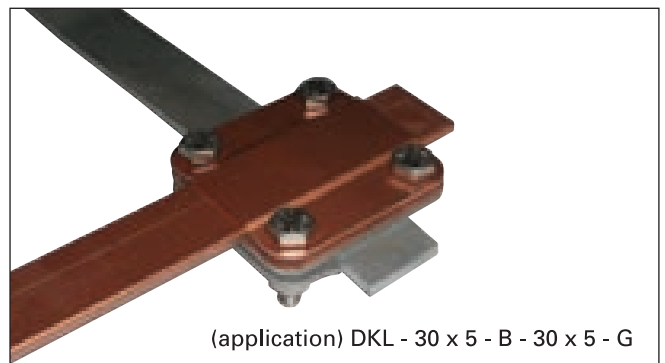
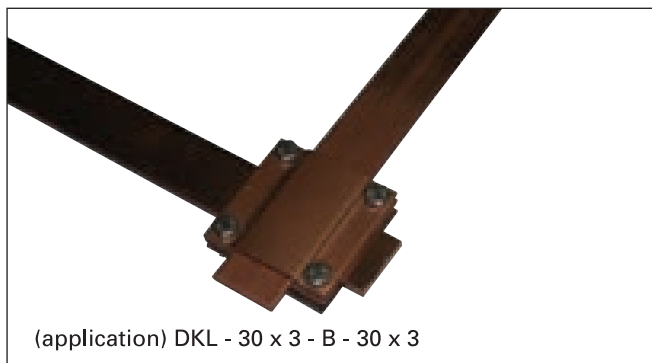

**DAĞITIM KLEMENSİ LAMA TİP / DISTRIBUTION CLAMP - STRIP MODEL**

üç parçalı / three-piece

Sipariş Kodu Reference No.	Lama Ölçüsü Galvanized Tape (mm)	Lama Ölçüsü Galvanized Tape (mm)	Malzeme Material
DKL-30x3-G-30x3	30x3	30x3	H.D.G.Steel
DKL-30x3-G-30x5	30x3	30x5	
DKL-30x3-G-40x3	30x3	40x3	
DKL-30x3-G-40x4	30x3	40x4	
DKL-30x3-G-40x5	30x3	40x5	
DKL-30x3-G-50x3	30x3	50x3	
DKL-30x3-G-50x5	30x3	50x5	
DKL-30x5-G-30x5	30x5	30x5	
DKL-30x5-G-40x3	30x5	40x3	
DKL-30x5-G-40x4	30x5	40x4	
DKL-30x5-G-40x5	30x5	40x5	
DKL-30x5-G-50x3	30x5	50x3	
DKL-30x5-G-50x5	30x5	50x5	
DKL-40x3-G-40x3	40x3	40x3	
DKL-40x3-G-40x4	40x3	40x4	
DKL-40x3-G-40x5	40x3	40x5	
DKL-40x3-G-50x3	40x3	50x3	
DKL-40x3-G-50x5	40x3	50x5	
DKL-40x4-G-40x4	40x4	40x4	
DKL-40x4-G-40x5	40x4	40x5	
DKL-40x4-G-50x3	40x4	50x3	
DKL-40x4-G-50x5	40x4	50x5	
DKL-40x5-G-40x5	40x5	40x5	
DKL-40x5-G-50x3	40x5	50x3	
DKL-40x5-G-50x5	40x5	50x5	
DKL-50x3-G-50x3	50x3	50x3	
DKL-50x3-G-50x5	50x5	50x5	



H.D.G. : Hot Dip Galvanized G: Electro Galvanized Bolts : Inox A2-70

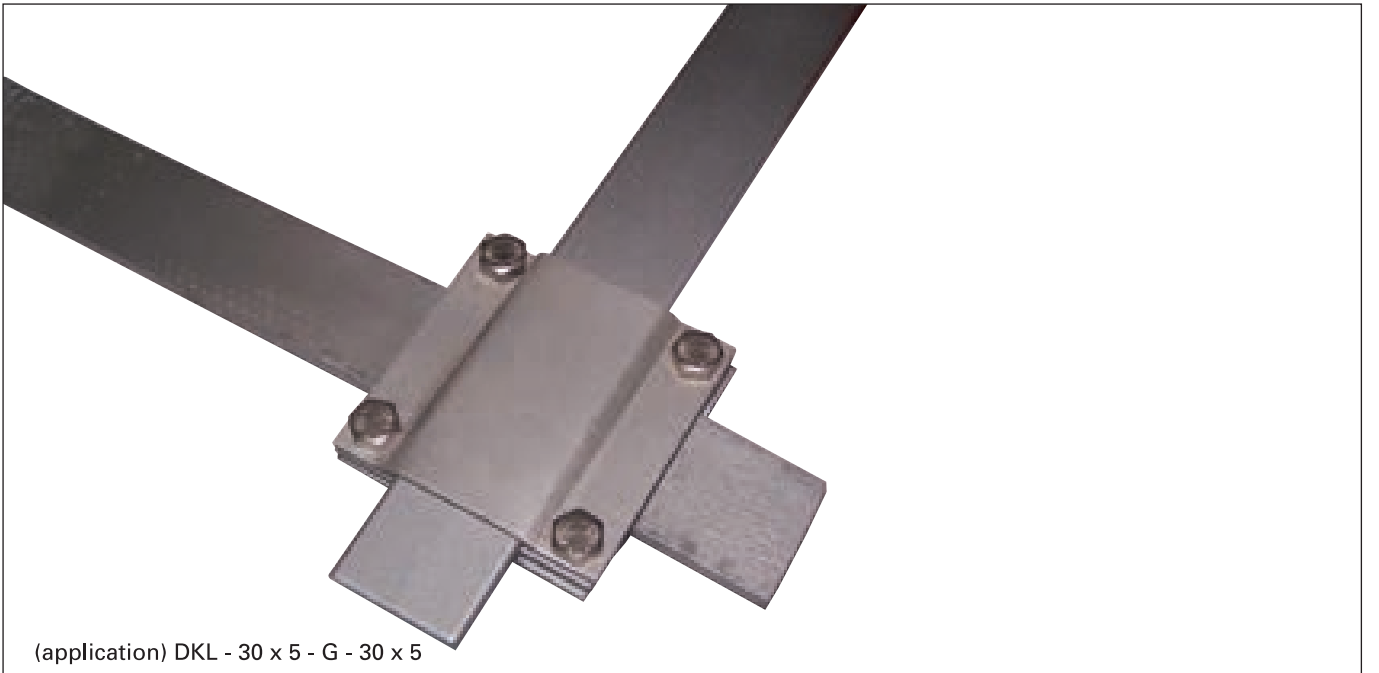

**DAĞITIM KLEMENSİ İLETKEN-LAMA TİP / DISTRIBUTION CLAMP**

**COPPER CABLE / COPPER TAPE**

üç parçalı / three-piece

Sipariş Kodu Reference No.	İletken Kesiti Conductor Range Ø(mm) (mm <sup>2</sup> )	Lama Ölçüsü Copper Tape (mm)	Malzeme Material
DKIL-50-B-30x3	8 50	30x3	COPPER
DKIL-50-B-30x5	8 50	30x5	
DKIL-50-B-40x3	8 50	40x3	
DKIL-50-B-40x5	8 50	40x5	
DKIL-50-B-50x3	8 50	50x3	
DKIL-50-B-50x5	8 50	50x5	
DKIL-70-B-30x3	10 70	30x3	
DKIL-70-B-30x5	10 70	30x5	
DKIL-70-B-40x3	10 70	40x3	
DKIL-70-B-40x5	10 70	40x5	
DKIL-70-B-50x3	10 70	50x3	
DKIL-70-B-50x5	10 70	50x5	
DKIL-95-B-30x3	95	30x3	
DKIL-95-B-30x5	95	30x5	
DKIL-95-B-40x3	95	40x3	
DKIL-95-B-40x5	95	40x5	
DKIL-95-B-50x3	95	50x3	
DKIL-95-B-50x5	95	50x5	
DKIL-120-B-30x3	120	30x3	
DKIL-120-B-30x5	120	30x5	
DKIL-120-B-40x3	120	40x3	
DKIL-120-B-40x5	120	40x5	
DKIL-120-B-50x3	120	50x3	
DKIL-120-B-50x5	120	50x5	
DKIL-120-B-60x4	120	60x4	
DKIL-120-B-60x5	120	60x5	
DKIL-150-B-30x3	150	30x3	
DKIL-150-B-30x5	150	30x5	
DKIL-150-B-40x3	150	40x3	
DKIL-150-B-40x5	150	40x5	
DKIL-150-B-50x3	150	50x3	
DKIL-150-B-50x5	150	50x5	



E-Cu: Electrolytic Copper

Bolts : Inox A2-70

İsteğe bağlı olarak dört parçalı imal edilir.  
Four-piece production is available upon request



**DAĞITIM KLEMENSİ İLETKEN-LAMA TİP / DISTRIBUTION CLAMP**

**COPPER CABLE / GALVANIZED TAPE**

**dört parçalı / four-piece**

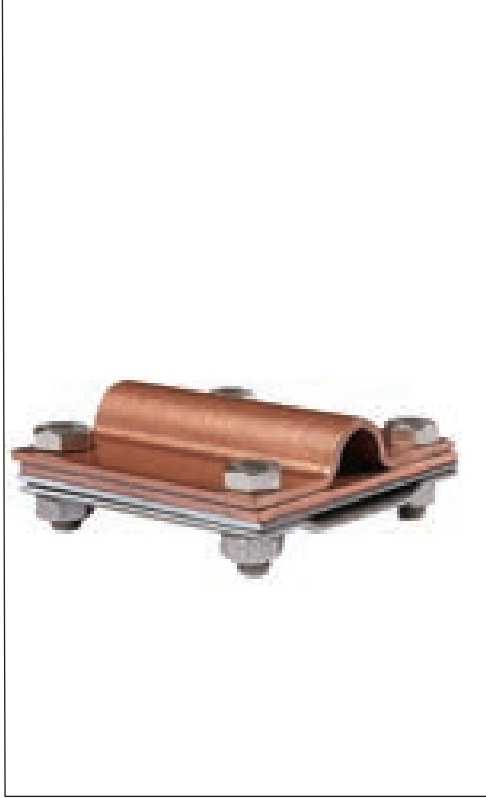

Sipariş Kodu Reference No.	İletken Kesiti Conductor Range Ø(mm) (mm <sup>2</sup> )		Lama Ölçüsü Galvanized Tape mm	Malzeme Material
DKIL-50-GB-30x3	8	50	30x3	E-Cu+H.D.G.S.
DKIL-50-GB-30x5	8	50	30x5	
DKIL-50-GB-40x3	8	50	40x3	
DKIL-50-GB-40x4	8	50	40x4	
DKIL-50-GB-40x5	8	50	40x5	
DKIL-50-GB-50x3	8	50	50x3	
DKIL-50-GB-50x5	8	50	50x5	
DKIL-50-GB-30x3	8	50	30x3	
DKIL-50-GB-30x5	8	50	30x5	
DKIL-50-GB-40x3	8	50	40x3	
DKIL-50-GB-40x5	8	50	40x5	
DKIL-50-GB-50x3	8	50	50x3	
DKIL-50-GB-50x5	8	50	50x5	
DKIL-70-GB-30x3	10	70	30x3	
DKIL-70-GB-30x5	10	70	30x5	
DKIL-70-GB-40x3	10	70	40x3	
DKIL-70-GB-40x4	10	70	40x4	
DKIL-70-GB-40x5	10	70	40x5	
DKIL-70-GB-50x3	10	70	50x3	
DKIL-70-GB-50x5	10	70	50x5	
DKIL-95-GB-30x3	95		30x3	
DKIL-95-GB-30x5	95		30x5	
DKIL-95-GB-40x3	95		40x3	
DKIL-95-GB-40x4	95		40x4	
DKIL-95-GB-40x5	95		40x5	
DKIL-95-GB-50x3	95		50x3	
DKIL-95-GB-50x5	95		50x5	
DKIL-120-GB-30x3	120		30x3	
DKIL-120-GB-30x5	120		30x5	
DKIL-120-GB-40x3	120		40x3	
DKIL-120-GB-40x4	120		40x4	
DKIL-120-GB-40x5	120		40x5	
DKIL-120-GB-50x3	120		50x3	
DKIL-120-GB-50x5	120		50x5	
DKIL-150-GB-30x3	150		30x3	
DKIL-150-GB-30x5	150		30x5	
DKIL-150-GB-40x3	150		40x3	
DKIL-150-GB-40x4	150		40x4	
DKIL-150-GB-40x5	150		40x5	
DKIL-150-GB-50x3	150		50x3	
DKIL-150-GB-50x5	150		50x5	
DKIL-185-GB-30x3	185		30x3	
DKIL-185-GB-30x5	185		30x5	
DKIL-185-GB-40x3	185		40x3	
DKIL-185-GB-40x4	185		40x4	
DKIL-185-GB-40x5	185		40x5	
DKIL-185-GB-50x3	185		50x3	
DKIL-185-GB-50x5	185		50x5	
DKIL-240-GB-30x3	240		30x3	
DKIL-240-GB-30x5	240		30x5	
DKIL-240-GB-40x3	240		40x3	
DKIL-240-GB-40x4	240		40x4	
DKIL-240-GB-40x5	240		40x5	
DKIL-240-GB-50x3	240		50x3	
DKIL-240-GB-50x5	240		50x5	

E-Cu: Electrolytic Copper

H.D.G. Steel : Hot Dip Galvanized Steel

Bolts : Inox A2-70

# SIKIŞTIRMALI TİP KABLO PABUÇLARI & KLEMENSLERİ

CRIMPING TYPE COPPER CABLE TERMINAL LUGS  
& CONNECTORS



**BİR-ER** ELEKTRİK SİSTEMLERİ YAPIM MÜHENDİSLİK SAN. ve TİC. LTD. ŞTİ.

**DIN 46235 KABLO PABUCU / COMPRESSION CABLE LUGS - AS PER DIN 46235**

**TIN-PLATED COPPER**



Sipariş Kodu Reference No.	İletken Kesiti Conductor Cross Section (mm <sup>2</sup> )	Civata Ölçüsü Terminal Bolt Diameter (metric)	Malzeme Material
DKP-10-M5	10	M5	E-Cu
DKP-10-M6	10	M6	
DKP-10-M8	10	M8	
DKP-16-M6	16	M6	
DKP-16-M8	16	M8	
DKP-16-M10	16	M10	
DKP-16-M12	16	M12	
DKP-25-M6	25	M6	
DKP-25-M8	25	M8	
DKP-25-M10	25	M10	
DKP-25-M12	25	M12	
DKP-35-M6	35	M6	
DKP-35-M8	35	M8	
DKP-35-M10	35	M10	
DKP-35-M12	35	M12	
DKP-35-M14	35	M14	
DKP-50-M8	50	M8	
DKP-50-M10	50	M10	
DKP-50-M12	50	M12	
DKP-50-M14	50	M14	
DKP-50-M16	50	M16	
DKP-70-M8	70	M8	
DKP-70-M10	70	M10	
DKP-70-M12	70	M12	
DKP-70-M14	70	M14	
DKP-70-M16	70	M16	
DKP-95-M8	95	M8	
DKP-95-M10	95	M10	
DKP-95-M12	95	M12	
DKP-95-M14	95	M14	
DKP-95-M16	95	M16	
DKP-120-M10	120	M10	
DKP-120-M12	120	M12	
DKP-120-M14	120	M14	
DKP-120-M16	120	M16	
DKP-120-M20	120	M20	
DKP-150-M10	150	M10	
DKP-150-M12	150	M12	
DKP-150-M14	150	M14	
DKP-150-M16	150	M16	
DKP-150-M20	150	M20	
DKP-185-M10	185	M10	
DKP-185-M12	185	M12	
DKP-185-M14	185	M14	
DKP-185-M16	185	M16	
DKP-185-M20	185	M20	
DKP-240-M10	240	M10	
DKP-240-M12	240	M12	
DKP-240-M14	240	M14	
DKP-240-M16	240	M16	
DKP-240-M20	240	M20	
DKP-300-M10	300	M10	
DKP-300-M12	300	M12	
DKP-300-M14	300	M14	
DKP-300-M16	300	M16	
DKP-300-M20	300	M20	

**STANDART KABLO PABUCU / COMPRESSION CABLE LUGS - STANDARD TYPE**

**TIN-PLATED COPPER**

Sipariş Kodu Reference No.	İletken Kesiti Conductor Cross Section (mm <sup>2</sup> )	Civata Ölçüsü Terminal Bolt Diameter (metric)	Malzeme Material
SKP-10-M5	10	M5	E-Cu
SKP-10-M6	10	M6	
SKP-10-M8	10	M8	
SKP-16-M6	16	M6	
SKP-16-M8	16	M8	
SKP-25-M6	25	M6	
SKP-25-M8	25	M8	
SKP-25-M10	25	M10	
SKP-25-M12	25	M12	
SKP-35-M6	35	M6	
SKP-35-M8	35	M8	
SKP-35-M10	35	M10	
SKP-35-M12	35	M12	
SKP-50-M8	50	M8	
SKP-50-M10	50	M10	
SKP-50-M12	50	M12	
SKP-70-M8	70	M8	
SKP-70-M10	70	M10	
SKP-70-M12	70	M12	
SKP-95-M8	95	M8	
SKP-95-M10	95	M10	
SKP-95-M12	95	M12	
SKP-120-M10	120	M10	
SKP-120-M12	120	M12	
SKP-120-M14	120	M14	
SKP-120-M16	120	M16	
SKP-150-M10	150	M10	
SKP-150-M12	150	M12	
SKP-150-M14	150	M14	
SKP-150-M16	150	M16	
SKP-185-M10	185	M10	
SKP-185-M12	185	M12	
SKP-185-M14	185	M14	
SKP-185-M16	185	M16	
SKP-240-M12	240	M12	
SKP-240-M14	240	M14	
SKP-240-M16	240	M16	
SKP-240-M20	240	M20	
SKP-300-M12	300	M12	
SKP-300-M16	300	M16	
SKP-300-M20	300	M20	

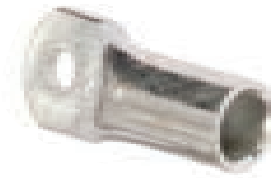

Standard Type



**EK MUFU / CONDUCTOR JUNCTION AS PER DIN 46267**

**TIN-PLATED COPPER**

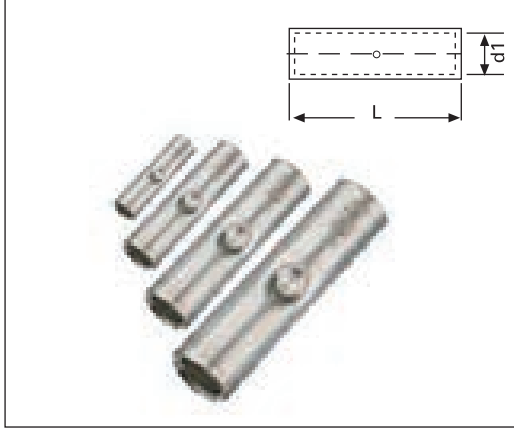

Sipariş Kodu Reference No.	İletken Kesiti Conductor Section (mm <sup>2</sup> )	Ebatları Size d1(mm) L(mm)	Malzeme Material
EM-16	16	5.5 50	E-Cu
EM-25	25	7 50	
EM-35	35	8.2 50	
EM-50	50	10 56	
EM-70	70	11.5 56	
EM-95	95	13.5 70	
EM-120	120	15.5 70	
EM-150	150	17 80	
EM-185	185	19 85	
EM-240	240	21.5 90	

**ÇİFT DELİKLİ KABLO PABUCU / COMPRESSION CABLE LUGS TWO HOLES**

**TIN-PLATED COPPER**

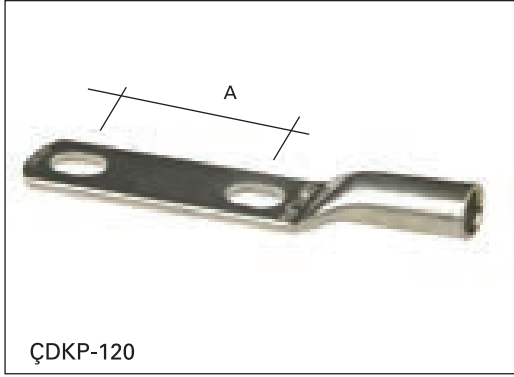

Sipariş Kodu Reference No.	İletken Kesiti Conductor Section (mm <sup>2</sup> )	Delikler Arası Ölçü Hole Range (mm) A(mm)	Malzeme Material
ÇDKP-35	35	2xØ12 53-66	E-Cu
ÇDKP-50	50	2xØ12 53-66	
ÇDKP-70	70	2xØ12 53-66	
ÇDKP-95	95	2xØ12 53-66	
ÇDKP-120	120	2xØ12 53-66	
ÇDKP-150	150	2xØ12 53-66	
ÇDKP-185	185	2xØ12 53-66	
ÇDKP-240	240	2xØ12 53-66	

for copper conductors to: DIN 48201  
tube dimensions: DIN 46235

**ÇİFT İLETKEN GİRİŞLİ KABLO PABUCU / DOUBLE CABLE INPUT, ONE HOLE**

**TIN-PLATED COPPER**

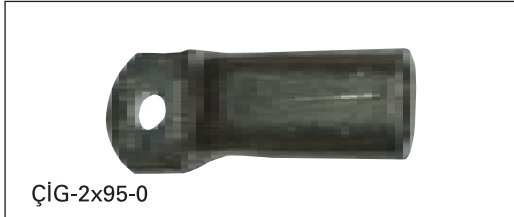

Sipariş Kodu Reference No.	İletken Kesiti Conductor Section (mm <sup>2</sup> )	Delik Ölçüsü Hole Size (mm)	Malzeme Material
ÇİG-2x70 - O	2x70	Ø13	E-Cu
ÇİG-2x95 - O	2x95	Ø13	
ÇİG-2x120 - O	2x120	Ø13	

for copper conductors to: DIN 48201

**ÇİFT İLETKEN GİRİŞLİ KABLO PABUCU / DOUBLE CABLE INPUT, TWO HOLES**

**TIN-PLATED COPPER**

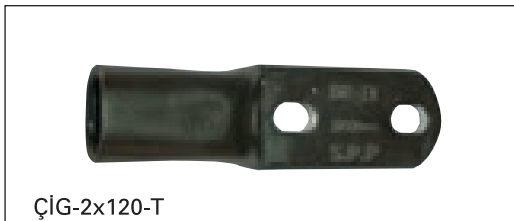

Sipariş Kodu Reference No.	İletken Kesiti Conductor Section (mm <sup>2</sup> )	Delikler Arası Ölçü Hole Range (mm) A(mm)	Malzeme Material
ÇİG-2x70 - T	2x70	2xØ12 53-66	E-Cu
ÇİG-2x95 - T	2x95	2xØ12 53-66	
ÇİG-2x120 - T	2x120	2xØ12 53-66	

for copper conductors to: DIN 48201

## H KLEMENSLER / H CLAMPS

TIN-PLATED COPPER

Sipariş Kodu Reference No.	İletken Kesiti Conductor Range (mm <sup>2</sup> )	İletken Kesiti Conductor Range (mm <sup>2</sup> )	Malzeme Material
HK-50-50	50	50	E-Cu
HK-70-70	70	70	
HK-95-95	95	95	
HK-120-120	120	120	
HK-150-150	150	150	
HK-50-70	50	70	
HK-50-95	50	95	
HK-50-120	50	120	
HK-50-150	50	150	
HK-70-95	70	95	
HK-70-120	70	120	
HK-70-150	70	150	
HK-95-120	95	120	
HK-95-150	95	150	



Surface : tin plated

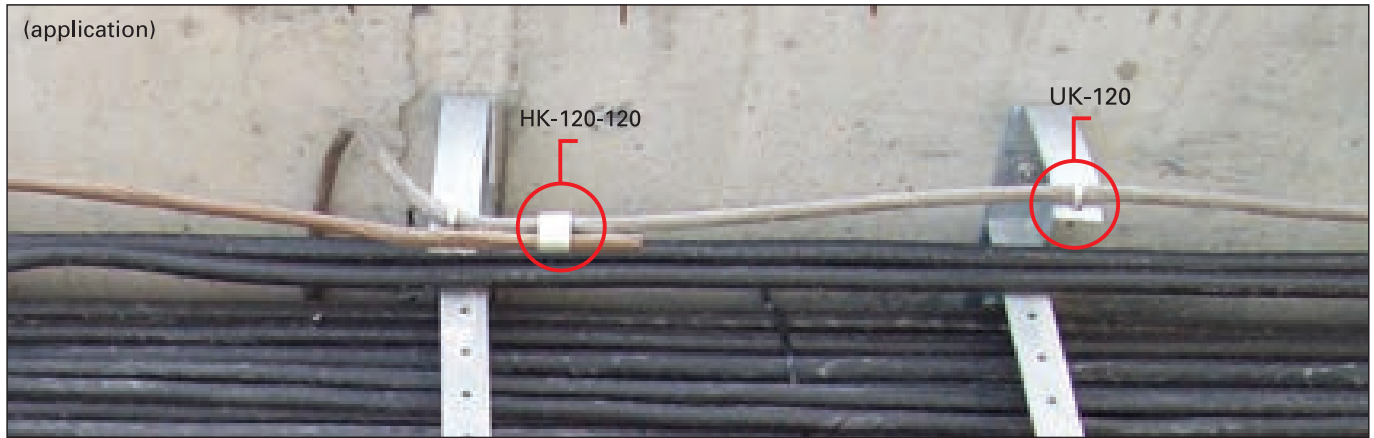

## C KLEMENSLER / C CLAMPS

TIN-PLATED COPPER

Sipariş Kodu Reference No.	İletken Kesiti Conductor Range (mm <sup>2</sup> )	İletken Kesiti Conductor Range (mm <sup>2</sup> )	Malzeme Material
CK-16-16	16	16	E-Cu
CK-25-25	25	25	
CK-35-35	35	35	
CK-50-50	50	50	
CK-70-70	70	70	
CK-95-95	95	95	
CK-120-120	120	120	
CK-150-150	150	150	
CK-185-185	185	185	
CK-240-240	240	240	
CK-50-16	50	16	
CK-50-25	50	25	
CK-50-35	50	35	
CK-70-16	70	16	
CK-70-25	70	25	
CK-70-35	70	35	
CK-95-35	95	35	



Surface : tin plated



# TOPRAKLAMA KROŐELERİ

## GROUNDING CLIPS



**BİR-ER** ELEKTRİK SİSTEMLERİ YAPIM MÜHENDİSLİK SAN. ve TİC. LTD. ŞTİ.

**TEK DELİKLİ KROŞE / ONE HOLE CABLE CLIP**

	Sipariş Kodu Reference No.	Delik Çapı Hole Size Ø (mm)	İletken Kesiti Conductor Section (mm <sup>2</sup> )	Malzeme Material
 TK-16-G-4	TK-16-B-4	4.8	16	COPPER
	TK-16-G-4	4.8	16	H.D.G.S
 TK-50-G-4 TK-50-B-4	TK-50-B-4	4.8	50	COPPER
	TK-50-G-4	4.8	50	H.D.G.S
	TK-50-B-6	6	50	COPPER
	TK-50-G-6	6	50	H.D.G.S
 TK-95-G-6 TK-95-B-6	TK-95-B-6	6.5	95	COPPER
	TK-95-İ-6	6.5	95	İNOX
	TK-95-G-6	6.5	95	H.D.G.S
	TK-120-B-6	6.5	120	COPPER
	TK-120-İ-6	6.5	120	İNOX
	TK-120-G-6	6.5	120	H.D.G.S
	TK-150-B-6	6.5	150	COPPER
	TK-150-İ-6	6.5	150	İNOX
	TK-150-G-6	6.5	150	H.D.G.S
	 TK-120-İ-8	TK-95-B-8	8.5	95
TK-95-İ-8		8.5	95	İNOX
TK-95-G-8		8.5	95	H.D.G.S
TK-120-B-8		8.5	120	COPPER
TK-120-İ-8		8.5	120	İNOX
TK-120-G-8		8.5	120	H.D.G.S
TK-150-B-8		8.5	150	COPPER
TK-150-P-8		8.5	150	İNOX
TK-150-G-8		8.5	150	H.D.G.S
 TK-120-İ-16 TK-120-B-16		TK-95-B-16	16	95
	TK-95-İ-16	16	95	İNOX
	TK-95-G-16	16	95	H.D.G.S
	TK-120-B-16	16	120	COPPER
	TK-120-İ-16	16	120	İNOX
	TK-120-G-16	16	120	H.D.G.S
	TK-150-B-16	16	150	COPPER
	TK-150-İ-16	16	150	İNOX
	TK-150-G-16	16	150	H.D.G.S
	 TK-95-B-16Y TK-120-İ-16Y	TK-95-B-16Y	16	95
TK-95-İ-16Y		16	95	İNOX
TK-95-G-16Y		16	95	H.D.G.S
TK-120-B-16Y		16	120	COPPER
TK-120-İ-16Y		16	120	İNOX
TK-120-G-16Y		16	120	H.D.G.S
TK-150-B-16Y		16	150	COPPER
TK-150-İ-16Y		16	150	İNOX
TK-150-G-16Y	16	150	H.D.G.S	

**H.D.G.S:** Hot Dip Galvanized Steel

**inox:** Stainless Steel

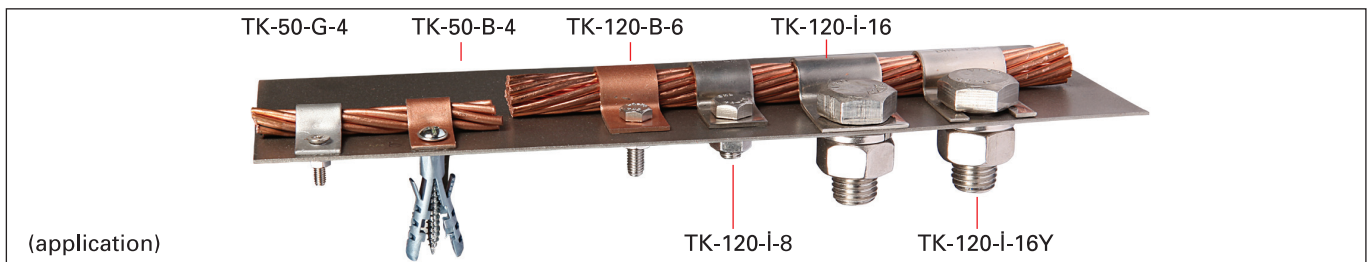

### TRİFON VİDALI KROŞE - İLETKEN / SCREW TYPE CLİP - SINGLE CONDUCTOR

Sipariş Kodu Reference No.	İletken Kesiti Conductor Ø(mm) (mm <sup>2</sup> )	Malzeme Material
TV-1x50-G	8 1x50	SCREW + COVER H.D.G., BOLTS Inox
TV-1x50-GB	8 1x50	SCREW H.D.G., COVER Cu, BOLTS Inox
TV-1x70-G	10 1x70	SCREW + COVER H.D.G., BOLTS Inox
TV-1x70-GB	10 1x70	SCREW H.D.G., COVER Cu, BOLTS Inox
TV-1x95-G	- 1x95	SCREW + COVER H.D.G., BOLTS Inox
TV-1x95-GB	- 1x95	SCREW H.D.G., COVER Cu, BOLTS Inox
TV-1x120-G	- 1x120	SCREW + COVER H.D.G., BOLTS Inox
TV-1x120-GB	- 1x120	SCREW H.D.G., COVER Cu, BOLTS Inox
TV-1x150-G	- 1x150	SCREW + COVER H.D.G., BOLTS Inox
TV-1x150-GB	- 1x150	SCREW H.D.G., COVER Cu, BOLTS Inox



### TRİFON VİDALI KROŞE - İLETKEN / SCREW TYPE CLİP - DOUBLE CONDUCTOR

TV-2x50-G	2xØ8 2x50	SCREW + COVER H.D.G., BOLTS Inox
TV-2x50-GB	2xØ8 2x50	SCREW H.D.G., COVER Cu, BOLTS Inox
TV-2x70-G	2xØ10 2x70	SCREW + COVER H.D.G., BOLTS Inox
TV-2x70-GB	2xØ10 2x70	SCREW H.D.G., COVER Cu, BOLTS Inox



### TRİFON VİDALI KROŞE - LAMA / SCREW TYPE CLİP - TAPE

Sipariş Kodu Reference No.	İletken Kesiti Conductor (mm)	Malzeme Material
TV-30x3-G	30x3 - 30x3,5	SCREW + COVER H.D.G., BOLTS Inox
TV-30x3-GB	30x3 - 30x3,5	SCREW H.D.G., COVER Cu, BOLTS Inox
TV-30x5-G	30x5	SCREW + COVER H.D.G., BOLTS Inox
TV-30x5-GB	30x5	SCREW H.D.G., COVER Cu, BOLTS Inox
TV-40x3-G	40x3	SCREW + COVER H.D.G., BOLTS Inox
TV-40x3-GB	40x3	SCREW H.D.G., COVER Cu, BOLTS Inox
TV-40x4-G	40x4	SCREW + COVER H.D.G., BOLTS Inox
TV-40x4-GB	40x4	SCREW H.D.G., COVER Cu, BOLTS Inox
TV-40x5-G	40x5	SCREW + COVER H.D.G., BOLTS Inox
TV-40x5-GB	40x5	SCREW H.D.G., COVER Cu, BOLTS Inox
TV-50x3-G	50x3	SCREW + COVER H.D.G., BOLTS Inox
TV-50x3-GB	50x3	SCREW H.D.G., COVER Cu, BOLTS Inox
TV-50x5-G	50x5	SCREW + COVER H.D.G., BOLTS Inox
TV-50x5-GB	50x5	SCREW H.D.G., COVER Cu, BOLTS Inox
TV-60x4-G	60x4 - 60x5	SCREW + COVER H.D.G., BOLTS Inox
TV-60x4-GB	60x4 - 60x5	SCREW H.D.G., COVER Cu, BOLTS Inox





## DUVAR KROŞESİ - İLETKEN / WALL CABLE CLIP

	Sipariş Kodu	İletken Kesiti	Malzeme
	Reference No.	Conductor Range (mm <sup>2</sup> )	Material
	DK-1x50-B	1x50	BODY+COVER COPPER, BOLTS INOX
	DK-1x50-G	1x50	BODY+COVER H.D.GALVANIZED, BOLTS INOX
	DK-1x50-GB	1x50	BODY H.D.GALVANIZED, COVER COPPER, BOLTS INOX
	DK-1x70-B	1x70	BODY+COVER COPPER, BOLTS INOX
	DK-1x70-G	1x70	BODY+COVER H.D.GALVANIZED, BOLTS INOX
	DK-1x70-GB	1x70	BODY H.D.GALVANIZED, COVER COPPER, BOLTS INOX
	DK-1x95-B	1x95	BODY+COVER COPPER, BOLTS INOX
	DK-1x95-G	1x95	BODY+COVER H.D.GALVANIZED, BOLTS INOX
	DK-1x95-GB	1x95	BODY H.D.GALVANIZED, COVER COPPER, BOLTS INOX
	DK-1x120-B	1x120	BODY+COVER COPPER, SCREW INOX
	DK-1x120-G	1x120	BODY+COVER H.D.GALVANIZED, BOLTS INOX
	DK-1x120-GB	1x120	BODY H.D.GALVANIZED, COVER COPPER, BOLTS INOX
	DK-1x150-B	1x150	BODY+COVER COPPER, BOLTS INOX
	DK-1x150-G	1x150	BODY+COVER H.D.GALVANIZED, BOLTS INOX
	DK-1x150-GB	1x150	BODY H.D.GALVANIZED, COVER COPPER, BOLTS INOX

## DUVAR KROŞESİ - LAMA / WALL TAPE CLIP

	Sipariş Kodu	Lama Ölçüsü	Malzeme
	Reference No.	Range - Tape (mm)	Material
	DK-30x3-B	30x3	BODY+COVER COPPER, BOLTS INOX
	DK-30x3-G	30x3	BODY+COVER H.D.GALVANIZED, BOLTS INOX
	DK-30x3-GB	30x3	BODY H.D.GALVANIZED, COVER COPPER, BOLTS INOX
	DK-30x5-P	30x5	BODY+COVER COPPER, BOLTS INOX
	DK-30x5-G	30x5	BODY+COVER H.D.GALVANIZED, BOLTS INOX
	DK-30x5-GB	30x5	BODY H.D.GALVANIZED, COVER COPPER, BOLTS INOX

## PİRİNÇ KROŞE / NAVAL BRASS CABLE CLIP

	Sipariş Kodu	İletken Kesiti	Malzeme	
	Reference No.	Conductor Range (mm)	Material	
	PK-50	1x50	NAVAL BRASS	(application) PK-120
	PK-70	1x70		
	PK-95	1x95		
	PK-120	1x120		
	PK-150	1x150		
	PK-185	1x185		
	PK-240	1x240		

## U KROŞE / U BOLT CLIPS

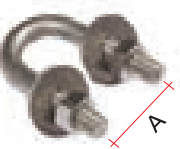
	Sipariş Kodu	İletken Kesiti	Delikler Arası Ölçü	Sıkma Aralığı	Malzeme
	Reference No.	Conductor Range (mm)	Hole Size A (mm)	Clamp Range (mm)	Material
	UK-95	1x95	20	8-14,5	M6 INOX
	UK-120	1x120	20	8-14,5	M6 INOX

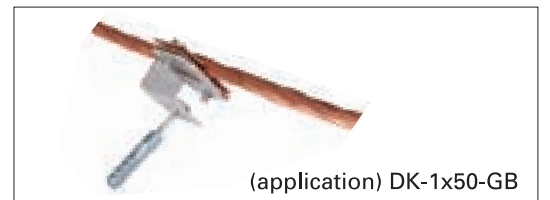

# KABLO KELEPÇELERİ

## CABLE CLEATS

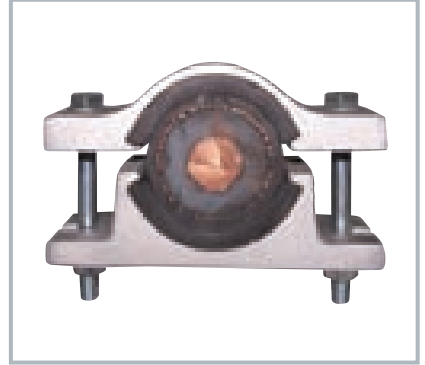
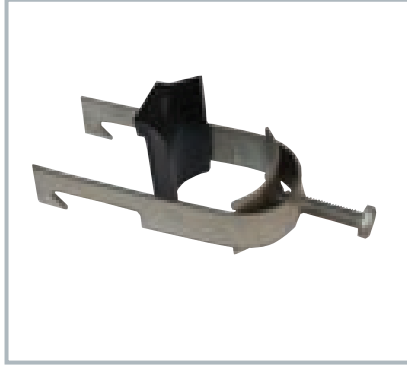
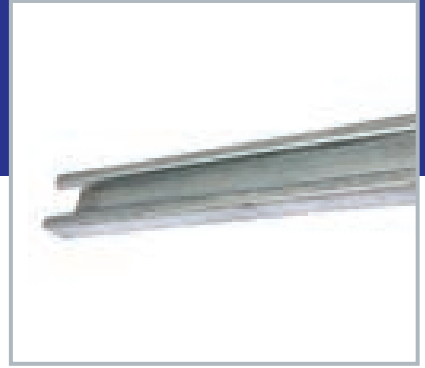

**BİR-ER** ELEKTRİK SİSTEMLERİ YAPIM MÜHENDİSLİK SAN. ve TİC. LTD. ŞTİ.



## KABLO KROŞESİ / CABLE CLIPS



Sipariş Kodu Reference No.	Kablo Sıkma Çapı Cable Diameter min.Ø(mm) max.Ø(mm)	Malzeme Material
KK-01	7 - 16	GALVANIZED SHEET
KK-02	13 - 20	
KK-03	17 - 25	
KK-04	22 - 28	

## KABLO KROŞE RAYI / CABLE X-RAIL

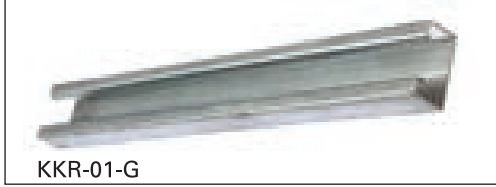

Sipariş Kodu Reference No.	Uzunluk Length (mm)	Malzeme Material
KKR-01-G	1000	GALVANIZED SHEET PROFILE
KKR-01-A	1000	ALUMINIUM PROFILE

## ALÜMİNYUM KABLO ETİKETİ / ALUMINIUM CABLE LABEL

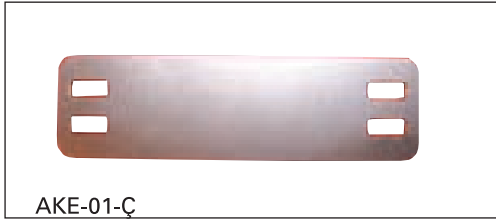

Sipariş Kodu Reference No.	Ölçü Dimensions (mm)	Malzeme Material
AKE-01	20x70	PLATE ALUMINIUM
AKE-02	Ø27	DISC ALUMINIUM
AKE-01-Ç	20x70	PLATE ALUMINIUM

AKE-01 ve AKE-01-Ç tip etiketler sipariş üzerine yazılı (kazımalı tipte) olarak hazırlanabilir.  
AKE-01 and AKE-01-Ç type of plates can be available with written marks on them

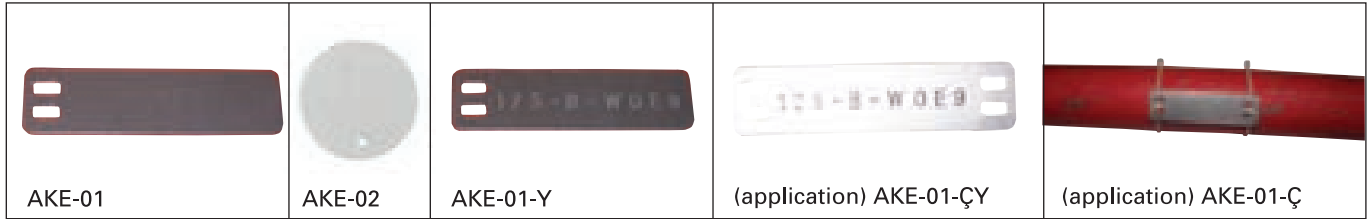

## ETİKET BAĞLAMA TELİ / LABEL BINDING WIRE



Sipariş Kodu Reference No.	Ölçü Dimensions (kg)	Malzeme Material
ET-01		ALUMINIUM
ET-02		INOX

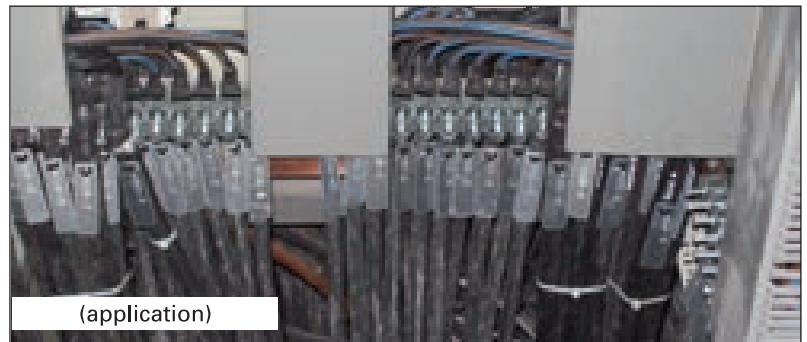
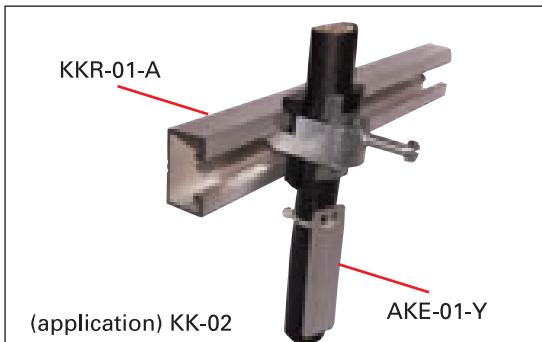

## ANTI-MANYETİK KROŞE / ANTI-MAGNETIC CLIP

Sipariş Kodu Reference No.	Kablo Sıkma Çapı Cable Diameter min.Ø(mm) max.Ø(mm)	Malzeme Material
AK-37	32-37	INOX
AK-40	38-40	
AK-42	41-42	
AK-44	43-44	
AK-46	45-46	
AK-48	47-48	
AK-52	49-52	
AK-58	53-58	
AK-69	64-69	
AK-75	70-75	



**Kullanılacak Köşebent Ölçüsünü Bildiriniz./ Please specify the size of the bracket**  
(40 x 40 mm) or (50 x 50 mm)

## OMEGA KABLO KROŞESİ / OMEGA CABLE CLAMP

Sipariş Kodu Reference No.	Kablo Sıkma Çapı Cable Diameter min.Ø(mm)max.Ø(mm)	Malzeme Material
OKK-38	38-46	ALUMINIUM
OKK-48	47-54	ALUMINIUM
OKK-37-P	37-45	PVC COATED ALUMINIUM
OKK-46-P	46-53	PVC COATED ALUMINIUM



## PE KABLO KROŞESİ / PE CABLE CLAMP

Sipariş Kodu Reference No.	Kablo Sıkma Çapı Overall Diameter of Cable Ø(mm)	Malzeme Material
PE-		POLIETİLEN



**Siparişlerinizde kablo dış çap ölçüsü bildiriniz./ Please specify the size of overall diameter of the cable**

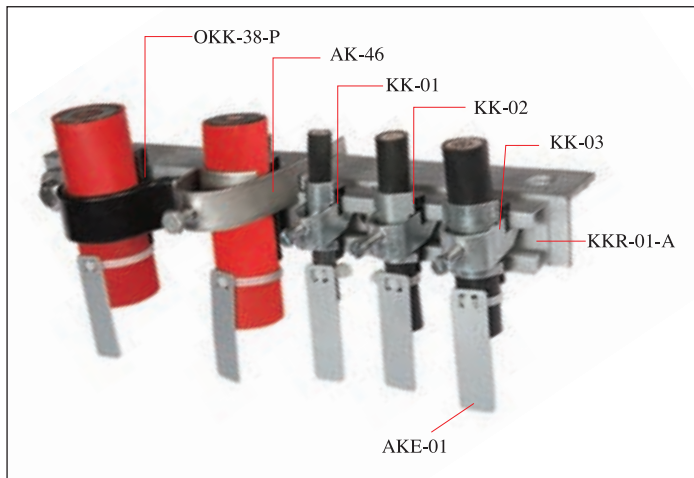

## ALÜMİNYUM KABLO KELEPÇESİ / ALUMINIUM CABLE CLEATS-SINGLE

LOW-MEDIUM VOLTAGE



Sipariş Kodu Reference No.	Kablo Sıkma Çapı Cable Diameter min. Ø (mm) max. Ø (mm)	Malzeme Material
ACC-34	34-35	Aluminium Casting
ACC-36	36-37	
ACC-38	38-39	
ACC-40	40-41	
ACC-42	42-43	
ACC-44	44-45	
ACC-46	46-47	
ACC-48	48-49	
ACC-50	50-51	
ACC-52	52-53	
ACC-54	54-55	
ACC-56	56-57	
ACC-58	58-59	
ACC-60	60-61	
ACC-62	62-63	
ACC-64	64-65	
ACC-66	66-67	
ACC-68	68-69	

Bolts : Inox A2 70

**Diğer ölçüler için irtibata geçiniz. Siparişlerinizde Kablo Dış Çap ölçüsünü bildiriniz.**

Contact us for other sizes. Please specify the size of overall diameter of the cable



(application) Uygulama 1 - ACC-48



(application) Uygulama 2 - ACC-48



(application) Uygulama 3 - ACC-48

## ALÜMİNYUM KABLO KELEPÇESİ / ALUMINIUM CABLE CLEATS-SINGLE

**HIGH VOLTAGE**

Sipariş Kodu Reference No.	Kablo Dış Çapı Overall Diameter of Cable Ø (mm)	Malzeme Material
ACC-1x80	1x80	Aluminium Casting
ACC-1x104	1x104	
ACC-1x106	1x106	
ACC-1x110	1x110	
ACC-1x138	1x138	

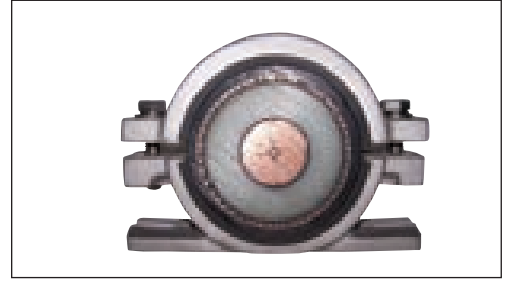

**Diğer ölçüler için irtibata geçiniz. Siparişlerinizde Kablo Dış Çap ölçüsünü bildiriniz.**

110kV - 500kV Kablo kelepçeleri için irtibata geçiniz.

*Please contact us for 110kV - 500kV cable clamps.*



(application) Uygulama 1 - ACC-1x110

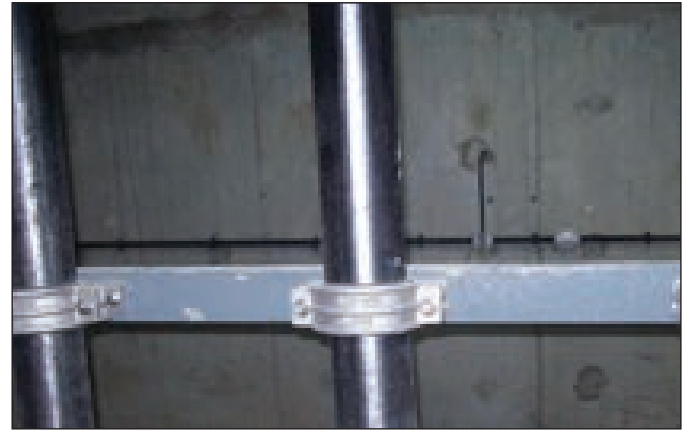

(application) Uygulama 2 - ACC-1x110



(application) Uygulama 1 - ACC-1x138

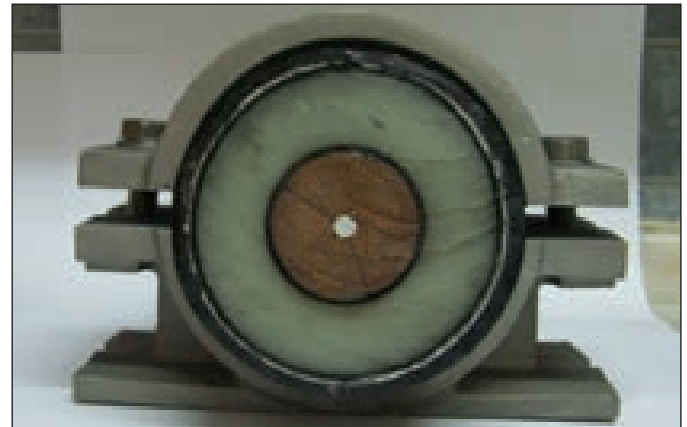

(application) Uygulama 2 - ACC-1x138

**ALÜMİNYUM KABLO KELEPÇESİ / ALUMINIUM CABLE CLEATS-TRIPLE**

**HIGH VOLTAGE**

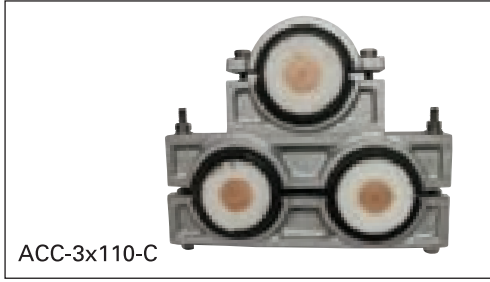

Sipariş Kodu Reference No.	Kablo Dış Çapı Overall Diameter of Cable Ø (mm)	Malzeme Material
ACC-3x80-C	3x80	Aluminium Casting
ACC-3x104-C	3x104	
ACC-3x106-C	3x106	
ACC-3x110-C	3x110	
ACC-3x138-C	3x138	

**Bolts :** Inox A2 70

**Diğer ölçüler için irtibata geçiniz. Siparişlerinizde Kablo Dış Çap ölçüsünü bildiriniz.**

110kV - 500kV Kablo kelepçeleri için irtibata geçiniz.

*Please contact us for 110kV - 500kV cable clamps.*

**ALÜMİNYUM KABLO KELEPÇESİ / ALUMINIUM CABLE CLEATS-TRIPLE**

**HIGH VOLTAGE**

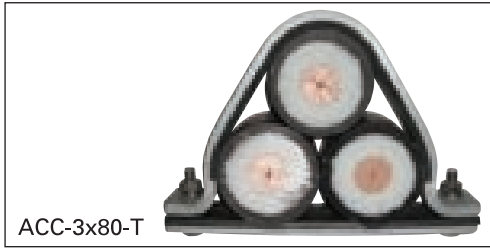

Sipariş Kodu Reference No.	Kablo Dış Çapı Overall Diameter of Cable Ø (mm)	Malzeme Material
ACC-3x80-T	3x80	Aluminium Tape
ACC-3x104-T	3x104	
ACC-3x106-T	3x106	
ACC-3x110-T	3x110	

**Bolts :** Inox A2 70

**Diğer ölçüler için irtibata geçiniz. Siparişlerinizde Kablo Dış Çap ölçüsünü bildiriniz.**

110kV - 500kV Kablo kelepçeleri için irtibata geçiniz.

*Please contact us for 110kV - 500kV cable clamps.*

**KISA DEVRE KELEPÇESİ / SHORT CIRCUIT STRAP**

**HIGH VOLTAGE**

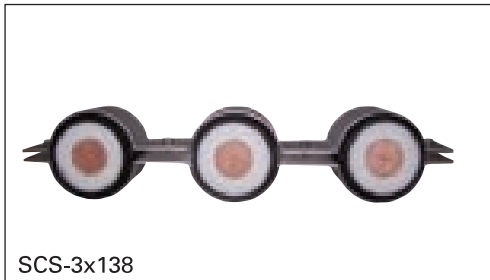

Sipariş Kodu Reference No.	Kablo Dış Çapı Overall Diameter of Cable Ø (mm)	Malzeme Material
SCS-3x80	3x80	Aluminium Tape
SCS-3x104	3x104	
SCS-3x106	3x106	
SCS-3x110	3x110	
SCS-3x138	3x138	

**Bolts :** Inox A2 70

**Diğer ölçüler için irtibata geçiniz. Siparişlerinizde Kablo Dış Çap ölçüsünü bildiriniz.**

110kV - 500kV Kablo kelepçeleri için irtibata geçiniz.

*Please contact us for 110kV - 500kV cable clamps.*



(application) ACC-1x138



(application) ACC-1x138

# AYDINLATMA VE YARDIMCI ELEMANLAR

## LIGHTING FITTINGS

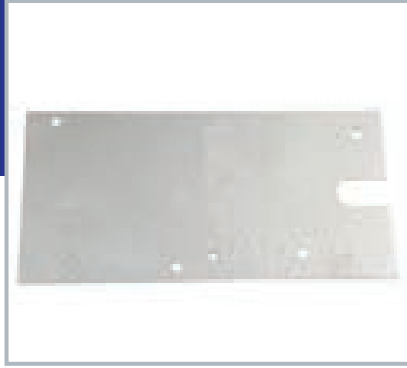

**BİR-ER** ELEKTRİK SİSTEMLERİ YAPIM MÜHENDİSLİK SAN. ve TİC. LTD. ŞTİ.

## AYDINLATMA ARMATÜRÜ / LIGHTING FIXTURES

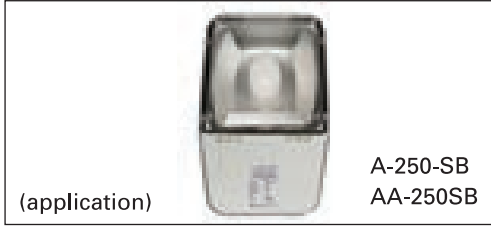

Sipariş Kodu Reference No.	Armatür Tipi Type	Açıklama Description
AA-100-DC	100W DC	E-27 DUYLU BOŞ ARMATÜR
AA-125-CB	125 W CB	CİVA BUHARLI BALASTLI
AA-250-CB	250 W CB	CİVA BUHARLI BALASTLI
AA-150-SB	150W SB	SODYUM BUHARLI BALASTLI
AA-250-SB	250 W SB	SODYUM BUHARLI BALASTLI

## AMPUL / LAMPS

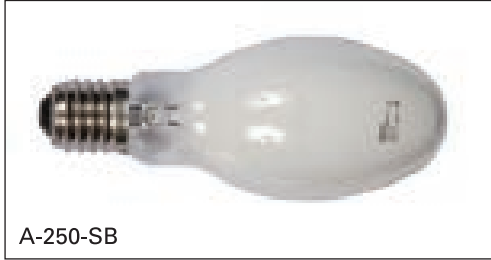

Sipariş Kodu Reference No.	Güç, Gerilim Power, Voltage (Watt) (Volt)	Açıklama Description
A-100-DC	100W 110V. DC	AKKOR FLAMANLI, Duy: E-27
A-125-CB	125W 220V. AC	CİVA BUHARLI, Duy: E-27
A-250-CB	250W 220V. AC	CİVA BUHARLI, Duy: E-40
A-150-SB	150W 220V. AC	SODYUM BUHARLI, Duy: E-40
A-250-SB	250W 220V. AC	SODYUM BUHARLI, Duy: E-40

## ARMATÜR BORUSU 60° / PIPE FOR ARMATURE

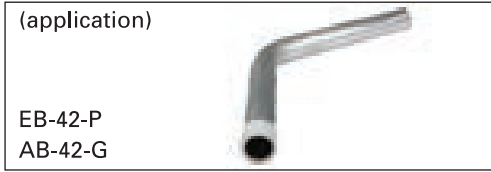

Sipariş Kodu Reference No.	Boru Çapı Pipe Diameter (mm)-(inch)	Malzeme Material
AB-42-G	42mm - 1 1/4"	H.D GALVANIZED
AB-40-A	40mm	ALUMINIUM

## ENTÜL



Sipariş Kodu Reference No.	Boru Çapı Pipe Diameter (mm)-(inch)	Malzeme Material
ES-42-K	42mm - 1 1/4"	BLACK RUBBER
ES-40-K	40mm	BLACK RUBBER
ES-1 1/2"-K	1 1/2"	BLACK RUBBER
ES-2"-K	2"	BLACK RUBBER
EB-42-P	42mm - 1 1/4"	WHITE NYLON-6
EB-40-P	40mm	WHITE NYLON-6
EB-1 1/2"-P	1 1/2"	WHITE NYLON-6
EB-2"-P	2"	WHITE NYLON-6

## ARMATÜR BORU KELEPÇESİ / PIPE CLAMP



Sipariş Kodu Reference No.	Sıkma Aralığı Clamp Range (mm) (inch)	Malzeme Material
ABK-39/44-İ	39-44mm.- 1 1/4"	INOX
ABK-39/44-G	39-44mm.- 1 1/4"	HOT DIP GALVANIZED

Bolts : Inox

## BUAT MONTAJ PARÇASI / JUNCTION BOX FIXING



Sipariş Kodu Reference No.	Ölçü Dimensions (mm)	Description Açıklama	Malzeme Material
BMP-200-İ	100x200	To Single J.Box(100x100)	INOX
BMP-200-G	100x200	To Single J.Box(100x100)	H.D.G.Steel
BMP-300-İ	100x300	To Double J.Box 2x(100x100)	INOX
BMP-300-G	100x300	To Double J.Box 2x(100x100)	H.D.G.Steel
BMP-330-İ	100x330	To Double J.Box 2x(100x130)	INOX
BMP-330-G	100x330	To Double J.Box 2x(100x130)	H.D.G.Steel

## HARİCİ BUAT IP67 / EXTERNAL JUNCTION BOX

Sipariş Kodu Reference No.	Ölçü Dimensions (mm)	Malzeme Material
HB-100	100x100x73	ALUMINIUM
HB-130	100x130x73	ALUMINIUM



## KROŞE MONTAJ PARÇASI / PLATE TO CLIP

Sipariş Kodu Reference No.	Ölçü Dimensions (mm)	Description Açıklama	Malzeme Material
KMP-200-İ	50x200	Single clip to J.Box(100x100)	INOX
KMP-200-G	50x200	Single clip to J.Box(100x100)	H.D.G.Steel
KMP-300-İ	50x300	Double clip to J.Box 2x(100x100)	INOX
KMP-300-G	50x300	Double clip to J.Box 2x(100x100)	H.D.G.Steel
KMP-330-İ	50x330	Double clip to J.Box 2x(100x130)	INOX
KMP-330-G	50x330	Double clip to J.Box 2x(100x130)	H.D.G.Steel

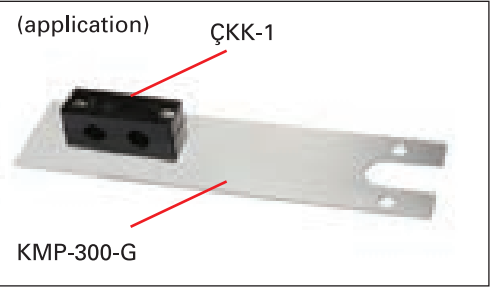

## ÇİFTLİ KABLO KROŞESİ / TWO CABLE CLIP

Sipariş Kodu Reference No.	Ölçü Dimensions (mm)	Kablo Sıkma Aralığı Cable Clip Range Ø (mm)	Malzeme Material
ÇKK-1	20x58x25	2x(10-13)	NYLON-6



Bolts : Inox

## YANMAZ SIRA KLEMENS / FIREPROOF TERMINAL

Sipariş Kodu Reference No.	Kablo Sıkma Aralığı Cable Clamp Range max.(mm <sup>2</sup> )	Ambalaj Miktarı / Packing Poşet / Pochette Koli / Box adet / pcs
YSK-1	4	12'li 50
YSK-2	6	12'li 50
YSK-3	10	10'lu 50
YSK-4	16	6'lı 50
YSK-5	25	6'lı 50



## HARİCİ PRİZ / OUTSIDE SOCKET

Sipariş Kodu Reference No.	Description Açıklama
HP-16A	3X16A, Monofaze, 2P+T, IP67 6h 200-250V
HP-125A	5X125A, Trifaze, 3P+N+T, IP67 6h 380-415V



## HARİCİ FİŞ / OUTSIDE PLUG

Sipariş Kodu Reference No.	Description Açıklama
HP-16A	3X16A, Monofaze, 2P+T, IP67 6h 200-250V
HP-125A	5X125A, Trifaze, 3P+N+T, IP67 6h 380-415V



## KAUÇUK KÖR TAPA / RUBBER BLIND PLUG

Sipariş Kodu Reference No.	Tip Model	Montaj Delik Çapı Hole Size Diameter Ø (mm)	Malzeme Material
KT-13.5	PG 13,5	17	RUBBER
KT-16	PG 16	22.8	
KT-21	PG 21	28.6	
KT-29	PG 29	37.3	
KT-36	PG 36	47	
KT-42	PG 42	55	





**KABLO RAKORU / CABLE GLANDS**

**NAVAL BRASS**



Sipariş Kodu Reference No.	Tip Model	Kablo Sıkma Aralığı Cable Clamp Range Ø(mm)	Montaj Delik Çapı Hole Size Diameter Ø (mm)
KR-7-N	PG 7	3 - 6,5	13
KR-9-N	PG 9	4 - 8	16
KR-11-N	PG 11	5 - 10	19
KR-13.5-N	PG 13,5	6 - 12	21
KR-16-N	PG 16	10 - 14	23
KR-21-N	PG 21	11 - 18	29
KR-29-N	PG 29	18 - 25	37.5
KR-36-N	PG 36	26 - 30	47.5
KR-42-N	PG 42	30 - 38	54.5
KR-48-N	PG 48	34 - 44	60

**N** : NİKEL KAPLI PİRİNÇ / NICKEL PLATED NAVAL BRASS

**NB**: PİRİNÇ / NAVAL BRASS

**KABLO RAKORU / CABLE GLANDS**

**POLYAMİD**



Sipariş Kodu Reference No.	Tip Model	Kablo Sıkma Aralığı Cable Clamp Range Ø(mm)	Montaj Delik Çapı Hole Size Diameter Ø (mm)
KR-7-P	PG 7	3 - 6,5	13
KR-9-P	PG 9	4 - 8	16
KR-11-P	PG 11	5 - 10	19
KR-13.5-P	PG 13,5	6 - 12	21
KR-16-P	PG 16	10 - 14	23
KR-21-P	PG 21	11 - 18	29
KR-29-P	PG 29	18 - 25	37.5
KR-36-P	PG 36	26 - 30	47.5
KR-42-P	PG 42	30 - 38	54.5
KR-48-P	PG 48	34 - 44	60

**P** : POLYAMİD

**KABLO BAĞI / CABLE TIES**



Sipariş Kodu Reference No.	En x Boy Width x Length (mm)	Ambalaj Miktarı / Packing	
		Poşet / Pochette adet / pcs	Koli / Box adet / pcs
KB-	2,5 x 98	1,000	50.000
KB-	2,5 x 135	100	12.000
KB-	2,6 x 200	100	8.000
KB-	3,6 x 140	100	7.000
KB-	3,6 x 200	100	7.000
KB-	3,6 x 290	100	4.500
KB-	4,5 x 160	100	6.000
KB-	4,8 x 200	100	4.000
KB-	4,8 x 250	100	4.500
KB-	4,8 x 290	100	3.500
KB-	4,8 x 360	100	3.000
KB-	7,8 x 180	100	2.500
KB-	7,8 x 240	100	2.000
KB-	7,8 x 300	100	1.500
KB-	7,8 x 365	100	1.500
KB-	7,8 x 450	100	3.000
KB-	7,8 x 540	100	2.000
KB-	7,8 x 750	100	2.000

## ISI İLE DARALAN MAKARON / HEAT SHRINKABLE TUBES

Sipariş Kodu Reference No.	İç Çapı(daralmadan) Inside Diameter		Ambalaj Packing (m)
	Önce Before	Ø (mm)) Sonra After	
DM-2	2.5	<1,0	200
DM-3	3.5	<1,5	200
DM-4.5	4.8	<2,3	200
DM-6	6.5	<3,0	200
DM-6,5	7.0	<3,3	100
DM-9	9.5	<4,5	100
DM-10	10.5	<5,0	100
DM-12	12.5	<6,0	100
DM-16	16.5	<8,0	100
DM-18	18.7	<9,0	100
DM-25	25.5	<12,5	50
DM-30	31.0	<15,0	50
DM-35	35.0	<19,0	50
DM-40	40.0	<21,0	50
DM-50	50.0	<27,0	50
DM-80	80.0	<40,0	20
DM-100	100.0	<50,0	20



Material: Polyolefin, halogen free Burning Class: Flame retardant (VW-1) 125°C Shrinkage Ratio: 2/1 (90°C)

## GALVANİZLİ BORU (DIŞLI) / GALVANIZED PIPE

Sipariş Kodu Reference No.	Boru Ölçüsü Pipe Dimension (inch)	Dış Çap (yaklaşık) Outside Diameter (approx.) (mm)	İç Çap (yaklaşık) Inside Diameter (approx.) (mm)	Net Ağırlık (yaklaşık) Net Weight (approx.) (kg / m)	Sevk Uzunluğu Delivery Length (m)
GB-1/2	1/2	21.3	16	1,300	6
GB-3/4	3/4	26.9	21,6	1,680	6
GB-1	1	33.7	27,2	2,570	6
GB-11/4	11/4	42.4	35,9	3,210	6
GB-11/2	11/2	48.3	42	3,810	6
GB-2	2	60.3	53,1	5,370	6
GB-21/2	21/2	76.1	68,9	6,890	6
GB-3	3	88.9	80,8	8,940	6
GB-4	4	114.3	105,3	12,790	6
GB-5	5	139.7	129,7	16,500	6
GB-6	6	165.1	155,1	20,500	6

## GALVANİZLİ DİKİŞSİZ BORU (DIŞSİZ) / GALVANIZED CONDUIT (TOSTHLESS)

Sipariş Kodu Reference No.	Boru Ölçüsü Pipe Dimension (inch)	Dış Çap (yaklaşık) Outside Diameter (approx.) (mm)	İç Çap (yaklaşık) Inside Diameter (approx.) (mm)	Net Ağırlık (yaklaşık) Net Weight (approx.) (kg / m)	Sevk Uzunluğu Delivery Length (m)
GDB-1/2	1/2	17.9	15.8	0.44	3.05
GDB-3/4	3/4	23.4	20.9	0.68	3.05
GDB-1	1	29.5	26.6	0.99	3.05
GDB-11/4	11/4	38.3	35	1.41	3.05
GDB-11/2	11/2	44.2	40.9	1,70	3.05
GDB-2	2	55.8	52.5	3,21	3.05
GDB-3	3	88.9	85.2	3,90	3.05
GDB-4	4	114.3	110.8	5,83	3.05

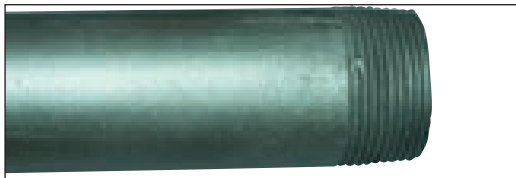

**SOMUNLU KELEPÇE / HEX NUT WELDED**

**ZINC-PLATED STEEL**



Sipariş Kodu Reference No.	Kelepçe Ölçüsü Pipe Diameter (inch)	Sıkma Aralığı Clamp Range (mm)	Malzeme Material
SK-1/2	1/2"	18-23	STEEL
SK-3/4	3/4"	27-31	
SK-1	1"	32-37	
SK-1 1/4	1 1/4"	39-44	
SK-1 1/2	1 1/2"	46-54	
SK-2	2"	54-61	
SK-2 1/2	2 1/2"	75-82	
SK-3	3"	83-89	
SK-4	4"	110-117	

**TRIFON VİDALI KELEPÇE / WOOD SCREW WELDED**

**ZINC-PLATED STEEL**



Sipariş Kodu Reference No.	Kelepçe Ölçüsü Pipe Diameter (inch)	Sıkma Aralığı Clamp Range (mm)	Malzeme Material
TVK-1/2	1/2"	18-23	STEEL
TVK-3/4	3/4"	27-31	
TVK-1	1"	32-37	
TVK-1 1/4	1 1/4"	39-44	
TVK-1 1/2	1 1/2"	46-54	
TVK-2	2"	54-61	
TVK-2 1/4	2 1/2"	75-82	
TVK-3	3"	83-89	
TVK-4	4"	110-117	

**BORU KELEPÇESİ TEK DELİKLİ / PIPE CLIP ONE HOLE**



Sipariş Kodu Reference No.	Boru Çapı Pipe Diameter (mm)-(inch)	Malzeme Material
BKT-10	10	GALVANIZED
BKT-10	10	HOT DIP GALVANIZED
BKT-12	12	GALVANIZED
BKT-12	12	HOT DIP GALVANIZED
BKT-16	16	GALVANIZED
BKT-16-G	16	HOT DIP GALVANIZED
BKT-20	20	GALVANIZED
BKT-20-G	20	HOT DIP GALVANIZED
BKT-25	25	GALVANIZED
BKT-25-G	25	HOT DIP GALVANIZED
BKT-32	32	GALVANIZED
BKT-32-G	32	HOT DIP GALVANIZED
BKT-40	40	GALVANIZED
BKT-40-G	40	HOT DIP GALVANIZED
BKT-50	50	GALVANIZED
BKT-50-G	50	HOT DIP GALVANIZED
BKT-1/2"	1/2"	GALVANIZED
BKT-1/2"-G	1/2"	HOT DIP GALVANIZED
BKT-3/4"	3/4"	GALVANIZED
BKT-3/4"-G	3/4"	HOT DIP GALVANIZED
BKT-1"	1"	GALVANIZED
BKT-1"-G	1"	HOT DIP GALVANIZED
BKT-1 1/4"	1 1/4"	GALVANIZED
BKT-1 1/4"-G	1 1/4"	HOT DIP GALVANIZED
BKT-1 1/2"	1 1/2"	GALVANIZED
BKT-1 1/2"-G	1 1/2"	HOT DIP GALVANIZED
BKT-2"	2"	GALVANIZED
BKT-2"-G	2"	HOT DIP GALVANIZED

## UYGULAMALAR / APPLICATIONS

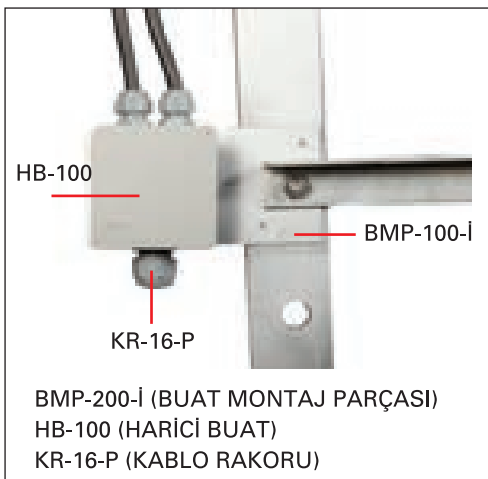
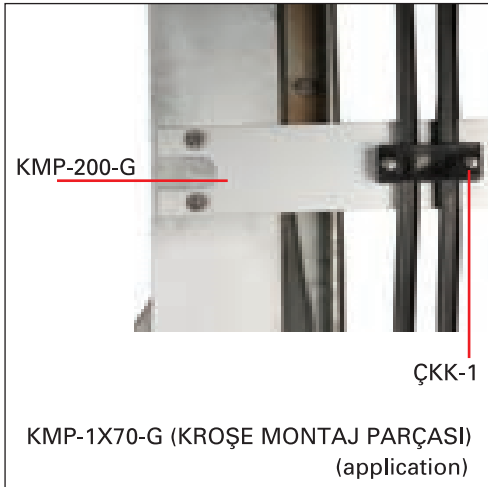
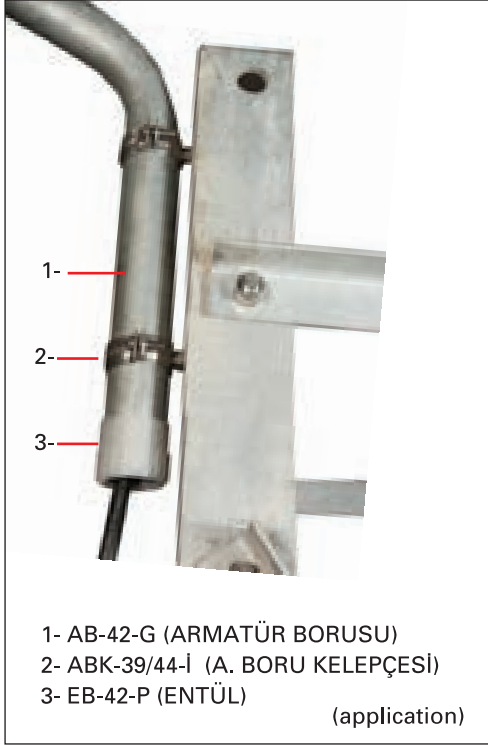

## BORU KELEPÇESİ ÇİFT DELİKLİ / PIPE CLIP DOUBLE HOLE



Sipariş Kodu Reference No.	Boru Çapı Pipe Diameter (mm)-(inch)	Malzeme Material
BKÇ-10	10	GALVANIZED
BKÇ-10	10	HOT GALVANIZED
BKÇ-12	12	GALVANIZED
BKÇ-12	12	HOT GALVANIZED
BKÇ-16	16	GALVANIZED
BKÇ-16-G	16	HOT GALVANIZED
BKÇ-20	20	GALVANIZED
BKÇ-20-G	20	HOT GALVANIZED
BKÇ-25	25	GALVANIZED
BKÇ-25-G	25	HOT GALVANIZED
BKÇ-32	32	GALVANIZED
BKÇ-32-G	32	HOT GALVANIZED
BKÇ-40	40	GALVANIZED
BKÇ-40-G	40	HOT GALVANIZED
BKÇ-50	50	GALVANIZED
BKÇ-50-G	50	HOT GALVANIZED
BKÇ-1/2"	1/2"	GALVANIZED
BKÇ-1/2"-G	1/2"	HOT GALVANIZED
BKÇ-3/4"	3/4"	GALVANIZED
BKÇ-3/4"-G	3/4"	HOT GALVANIZED
BKÇ-1"	1"	GALVANIZED
BKÇ-1"-G	1"	HOT GALVANIZED
BKÇ-1 1/4"	1 1/4"	GALVANIZED
BKÇ-1 1/4"-G	1 1/4"	HOT GALVANIZED
BKÇ-1 1/2"	1 1/2"	GALVANIZED
BKÇ-1 1/2"-G	1 1/2 "	HOT GALVANIZED
BKÇ-2"	2"	GALVANIZED
BKÇ-2"-G	2"	HOT GALVANIZED

# BARA TUTUCU

## BAR FIXING

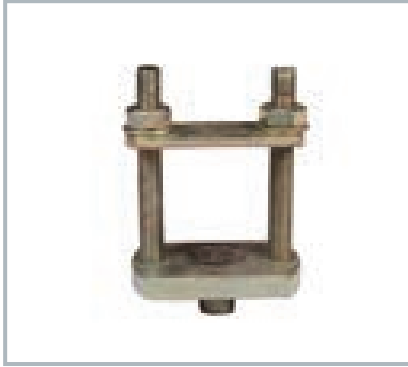
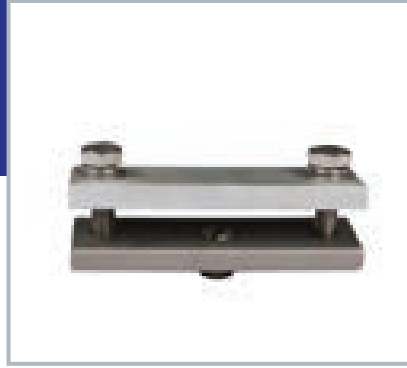
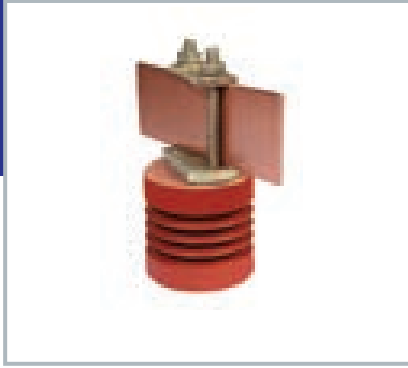

**BİR-ER** ELEKTRİK SİSTEMLERİ YAPIM MÜHENDİSLİK SAN. ve TİC. LTD. ŞTİ.

## DİK BARA TUTUCU / VERTICAL BAR FIXING

DAHİLİ TİP / INDOOR

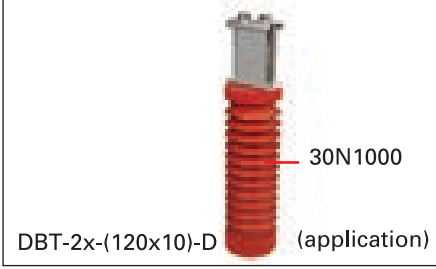

Sipariş Kodu Reference No.	Bara Ebatları Bar Dimension (mm)	İzolatör Tipi Insulator Type	Malzeme Material
DBT-2x(....x....) D	2x(....x.....)	30N1000	GALVANIZED

Özel isteklerinizde, izolatör delik detayı ve bara ölçüsü bildiriniz.  
Please specify top insulator hole detail and the size of the bar.

DAHİLİ TİP / INDOOR

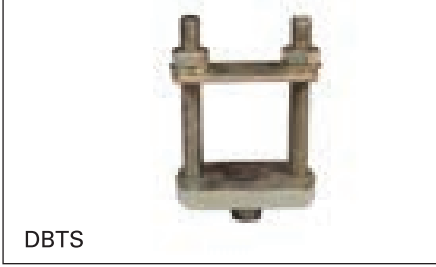

Sipariş Kodu Reference No.	Bara Ebatları Bar Dimension (mm)	İzolatör Tipi Insulator Type	Malzeme Material
DBTS-1x(....x....)D	1x(....x.....)	30N1000	GALVANIZED
DBTS-2x(....x....)D	2x(....x.....)		

Özel isteklerinizde, izolatör delik detayı ve bara ölçüsü bildiriniz.  
Please specify top insulator hole detail and the size of the bar.

HARİCİ TİP / OUTDOOR



Sipariş Kodu Reference No.	Bara Ebatları Bar Dimension (mm)	İzolatör Tipi Insulator Type	Malzeme Material
DBT-2x(....x....)H	2x(....x.....)	C4-170	INOX / H.D.GALVANIZED

Özel isteklerinizde, izolatör delik detayı ve bara ölçüsü bildiriniz.  
Please specify top insulator hole detail and the size of the bar.

**Bolts :** Inox A2-70



## YATAY BARA TUTUCU / HORIZONTAL BAR FIXING

DAHİLİ TİP / *INDOOR*

Sipariş Kodu Reference No.	Bara Ebatları Bar Dimension (mm)	İzolatör Tipi Insulator Type	Malzeme Material
YBT-1x-D	1x(.....x.....)	30N 1000	GALVANIZED
YBT-2x-D	2x(.....x.....)	30N 1000	GALVANIZED

Özel isteklerinizde, izolatör delik detayı ve bara ölçüsü bildiriniz.  
Please specify top insulator hole detail and the size of the bar.

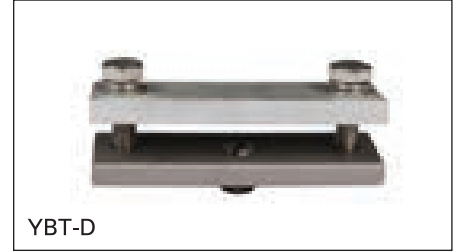

HARİCİ TİP / *OUTDOOR*

Sipariş Kodu Reference No.	Bara Ebatları Bar Dimension (mm)	İzolatör Tipi Insulator Type	Malzeme Material
YBT-1x-H	1x(.....x.....)	C4-170	H. D. GALVANIZED
YBT-2x-H	2x(.....x.....)	C4-170	H. D. GALVANIZED

Özel isteklerinizde, izolatör delik detayı ve bara ölçüsü bildiriniz.  
Please specify top insulator hole detail and the size of the bar.

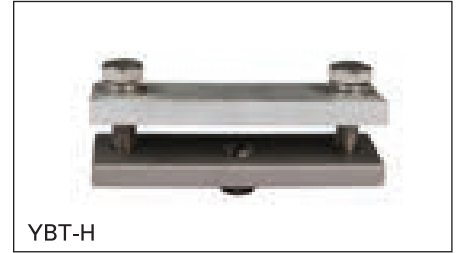

**Bolts** : Inox A2-70

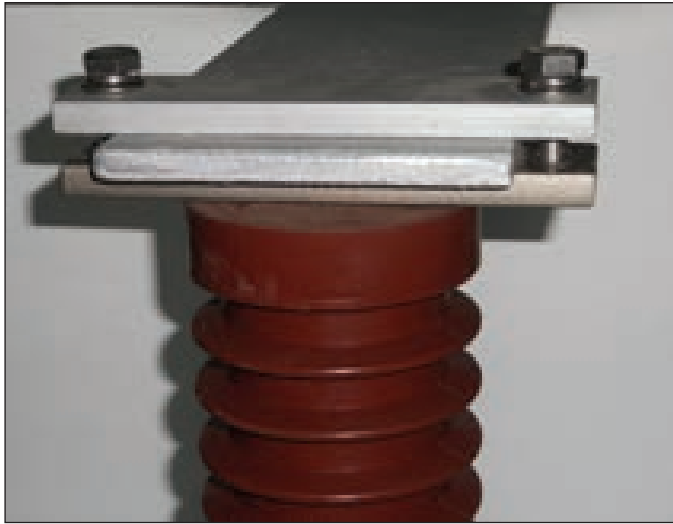
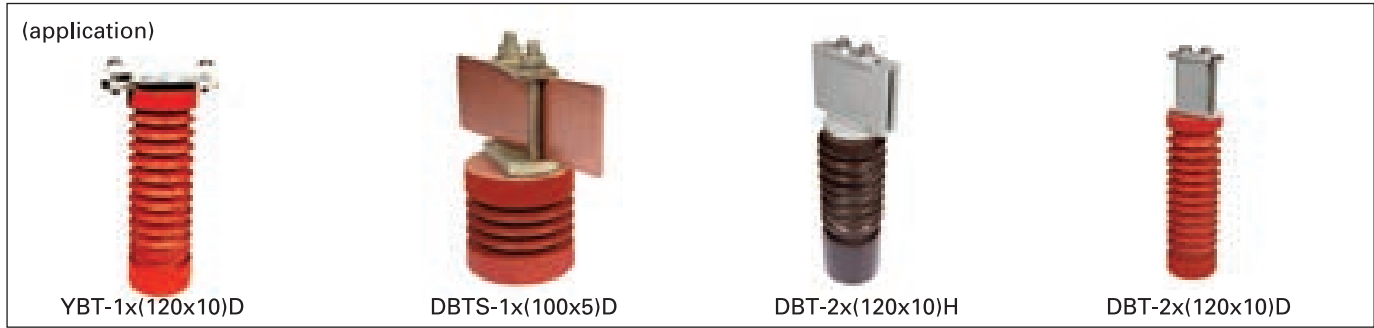

(application) YBT-1x(120x10)-D





# UYARI - İSİM LEVHALARI

## SIGNS & CHEMICALS



### ÖLÜM TEHLİKE LEVHASI / DANGER OF DEATH SIGN

Sipariş Kodu Reference No.	Ölçü Dimensions (mm)	Renk Colour	Malzeme Material
ÖTL-15X25	150x250	Naturel	ALUMINIUM
ÖTL-15x23	150x230	Yellow	

### FİDER İSİM LEVHASI / FEEDER NAME SIGN

Sipariş Kodu Reference No.	Açıklama Description	Ölçü Dimensions (mm)	Malzeme Material
AB-1	ANA BARA I	300x1000	ALUMINIUM
AB-2	ANA BARA II	300x1000	
TB	TRANSFER	300x1000	
KB	KUBLAJ	300x1000	

Trafo ve çıkış fiderleri için isim ve ölçü bildiriniz. / Please specify the name and the other size

### FAZ PLAKALARI / PHASE SIGNS

Sipariş Kodu Reference No.	Ölçü Dimensions (mm)	Renk Colour	Malzeme Material
FP-A-1	170x220	RED	ALUMINIUM
FP-B-1	170x220	YELLOW	
FP-C-1	170x220	BLUE	
FP-A-2	250x250	RED	
FP-B-2	250x250	YELLOW	
FP-C-2	250x250	BLUE	

### MANEVRA İSİM PLAKALARI / MANEUVER NAME SIGNS

Sipariş Kodu Reference No.	Ölçü Dimensions (mm)	Kalınlık Thickness (mm)	Malzeme Material
MP-P	150x150	3	PLEXIGLASS
MP-A	150x150	2	ALUMINIUM

İsim ve ölçü bildiriniz./ Please specify the name and the other size

### MANEVRA İSİM PLAKASI TUTTURMA PARÇASI / MANEUVEA PLATE FIXING

Sipariş Kodu Reference No.	Ölçü Dimensions (mm)	Kalınlık Thickness (mm)	Malzeme Material
İP-I	150x200	1,5	INOX
İPT-A	150x200	2	ALUMINIUM



**BOYA - KİMYASAL / PAINT - CHEMICALS**

Sipariş Kodu Reference No.	Açıklama Characteristics	Ağırlık Weight (ml) (kg)
ZINC 300	<b>GALVANİZLİ BOYA / GALVANIZED PAINT</b>	1 kg
ZS-893114	<b>ÇİNKO SPREY / ZINC SPRAY</b>	400ml
LONGTERM 2 PLUS	<b>INOX CİVATA GRESİ / INOX BOLT GREASE</b>	0,2 kg
YİM-AL	<b>YARI İLETKEN MACUN / SEMI-CONDUCTOR GREASE</b>	1 kg
CG-Cu/Al	<b>KONTAK GRESİ / CONTACT GREASE FOR COPPER AND ALUMINIUM (-20° to +200°C) melting point +260°C</b>	0,4 kg
CG-Al	<b>KONTAK GRESİ / CONTACT GREASE FOR ALUMINIUM melting point +80°C</b>	0,4 kg
LP-089027	<b>KAÇAK ARAMA SPREYİ / LECKSUCHER PLUS</b>	400ml
K-R	<b>KIRMIZI BOYA / RED PAINT</b>	1 kg
S-Y	<b>SARI BOYA / YELLOW PAINT</b>	1 kg
M-B	<b>MAVİ BOYA / BLUE PAINT</b>	1 kg
S-B	<b>SİYAH BOYA / BLACK PAINT</b>	1 kg



(application)





# HAVAİ HAT MALZEMELERİ

## OVERHEAD LINE TERMINALS

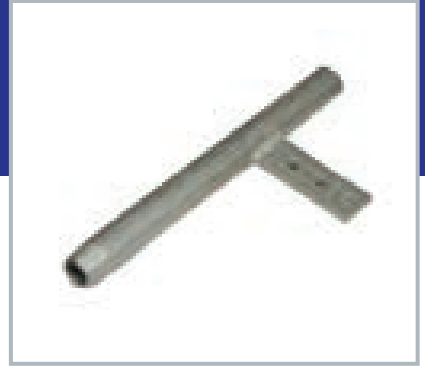

**BİR-ER** ELEKTRİK SİSTEMLERİ YAPIM MÜHENDİSLİK SAN. ve TİC. LTD. ŞTİ.

## TAMİR MANŞONU / Compression Repair Sleeves

Sipariş Kodu Reference No.	Canadian Standard		Toplam İletken Kesiti Total Conductor Section (mm <sup>2</sup> )	İletken Dış Çap Wire Outside Diameter (mm)	Malzeme Material
	İletken Adı Conductor Type ACSR	Kesit AWG Section			
CRS-477	Hawk	477	280.84	21.77	ALUMINIUM
CRS-795	Drake	795	468.00	28.11	ALUMINIUM
CRS-954	Cardinal	954	547.34	30.42	ALUMINIUM
CRS-1272	Pheasant	1272	726.79	35.10	ALUMINIUM

KULLANILACAK ALÜMİNYUM İLETKEN İLE İLGİLİ STANDART / THE STANDARD OF ALUMINIUM CONDUCTOR TS IEC 1088



## JUMPER TERMİNALİ / Jumper Terminals

Sipariş Kodu Reference No.	Canadian Standard		Toplam İletken Kesiti Total Conductor Section (mm <sup>2</sup> )	İletken Dış Çap Wire Outside Diameter (mm)	Malzeme Material
	İletken Adı Conductor Type ACSR	Kesit AWG Section			
JT-477	Hawk	477	280.84	21.77	ALUMINIUM
JT-795	Drake	795	468.00	28.11	
JT-954	Cardinal	954	547.34	30.42	
JT-1272	Pheasant	1272	726.79	35.10	

KULLANILACAK ALÜMİNYUM İLETKEN İLE İLGİLİ STANDART / THE STANDARD OF ALUMINIUM CONDUCTOR TS IEC 1088



## DURDURUCU KLEMENS / Compression Dead End

Sipariş Kodu Reference No.	Canadian Standard		Toplam İletken Kesiti Total Conductor Section mm <sup>2</sup>	İletken Dış Çap Wire Outside Diameter (mm)	Malzeme Material
	İletken Adı Conductor Type ACSR	Kesit AWG Section			
CDE-477	Hawk	477	280.84	21.77	ALUMINIUM
CDE-795	Drake	795	468.00	28.11	ALUMINIUM
CDE-954	Cardinal	954	547.34	30.42	ALUMINIUM
CDE-1272	Pheasant	1272	726.79	35.10	ALUMINIUM

KULLANILACAK ALÜMİNYUM İLETKEN İLE İLGİLİ STANDART/THE STANDARD OF ALUMINIUM CONDUCTOR TS IEC 1088



# TERMOKAYNAK ÜRÜNLER

## EXOTHERMIC WELDING



EXOTHERMIC  
WELDING  
APLIWELD®



BİR-ER ELEKTRİK SİSTEMLERİ YAPIM MÜHENDİSLİK SAN. ve TİC. LTD. ŞTİ.



## KAYNAK TOZU/ WELDING MIXTURE



Sipariş Kodu Reference No.	Kaynak Tozu Weld. Mixt. Weight (gr)	Ambalaj Miktarı Packing Box adet /pcs
AT-E032	32	10
AT-E045	45	10
AT-E065	65	10
AT-E090	90	10
AT-E115	115	10
AT-E150	150	10
AT-E200	200	10
AT-E250	250	10

Please contact us

## POTA / MOULDS



Sipariş Kodu Reference No.	Pota Tipi Mould Type	Açıklama Description
AP-A	CABLE - CABLE	T Horizontal
AP-B	CABLE - CABLE	Cross
AP-C	CABLE - ROD	T Vertical
AP-D	TAPE - TAPE	Cross
AP-E	TAPE - TAPE	T Vertical
AP-F	TAPE - ROD	T Horizontal

Please contact us

## POTA PENSESİ / HANDLE CLAMP



Sipariş Kodu Reference No.	Tipi Type
PP - 50N	Universal

## AKSESUARLAR / ACCESSORIES



Sipariş Kodu Reference No.	Açıklama Description
AK-1	Çakmak / Flint Igniters
AK-2	Pota Cüruf Kazıyıcı / Slag Scraper
AK-3	İletken Temizleme Fırçası / Conductor Cleaning Brush
AK-4	Koruyucu Eldiven / Safety Gloves
AK-5	Koruyucu Gözlük / Safety Goggles

# CİVATALAR

## BOLTS



**BİR-ER** ELEKTRİK SİSTEMLERİ YAPIM MÜHENDİSLİK SAN. ve TİC. LTD. ŞTİ.

**304 A2 KALİTE PASLANMAZ CİVATA / HEXAGON BOLTS**

**DIN 933-931**

Sipariş Kodu Reference No.	BOY Lenght (mm)	ÖLÇÜ Size (metric) (mm)										
		M4	M5	M6	M8	M10	M12	M14	M16	M18	M20	M24
HB-M....x....	10	X	X	X	X							
HB-M....x....	12	X	X	X	X							
HB-M....x....	16	X	X	X	X	X						
HB-M....x....	20	X	X	X	X	X	X	X	X			
HB-M....x....	25	X	X	X	X	X	X	X	X			
HB-M....x....	30	X	X	X	X	X	X	X	X	X	X	
HB-M....x....	35	X	X	X	X	X	X	X	X	X	X	
HB-M....x....	40	X	X	X	X	X	X	X	X	X	X	X
HB-M....x....	45		X	X	X	X	X	X	X	X	X	X
HB-M....x....	50	X	X	X	X	X	X	X	X	X	X	X
HB-M....x....	55	X		X		X	X		X			
HB-M....x....	60	X	X	X	X	X	X	X	X	X	X	X
HB-M....x....	65					X	X		X			
HB-M....x....	70			X	X	X	X	X	X	X	X	X
HB-M....x....	75								X		X	
HB-M....x....	80				X	X	X	X	X	X	X	X
HB-M....x....	90				X	X	X	X	X	X	X	X
HB-M....x....	100				X	X	X	X	X	X	X	X
HB-M....x....	110				X	X	X		X		X	
HB-M....x....	120				X	X	X	X	X	X	X	X
HB-M....x....	130					X	X	X				
HB-M....x....	140					X	X	X				
HB-M....x....	150					X	X	X	X	X	X	X
HB-M....x....	160					X	X		X			
HB-M....x....	170											
HB-M....x....	180					X	X		X			
HB-M....x....	200					X	X		X		X	X

Reference : (metric) x lenght (mm)

Inox : Stainless Steel

Material :Inox



**SOMUN / HEXAGON NUT DIN 934 A2 304**

Sipariş Kodu Reference No.	Malzeme Material
HN-M.3	INOX
HN-M.4	
HN-M.5	
HN-M.6	
HN-M.8	
HN-M.10	
HN-M.12	
HN-M.14	
HN-M.16	
HN-M.18	
HN-M.20	
HN-M.22	
HN-M.24	
HN-M.27	
HN-M.30	

**PUL / WASHER**

**DIN 125 A2 304**

Sipariş Kodu Reference No.	Ölçü Dimension (mm)
W- M.3	7*3.5*0.5
W- M.4	9*4.3*0.8
W- M.5	10*5.3*1
W- M.6	12*6.4*1.8
W- M.8	16*8.4*1.6
W- M.10	20*10.5*2
W- M.12	24*13*2.5
W- M.14	28*15*2.5
W- M.16	30*17*3
W- M.18	34*19*3
W- M.20	37*21*3
W- M.22	39*23*3
W- M.24	44*25*4
W- M.27	50*28*4
W- M.30	56*31*4

**SAPLAMA / GIJON DIN 975 A2 304**

Sipariş Kodu Reference No.	Ölçü Dimension (mm)	Boy Length (mm)	Malzeme Material
G - M.5	M.5 x1000	1000	INOX
G - M.6	M.6 x1000	1000	
G - M.8	M.8 x1000	1000	
G - M.10	M.10x1000	1000	
G - M.12	M.12x1000	1000	
G - M.14	M.14x1000	1000	
G - M.16	M.16x1000	1000	
G - M.18	M.18x1000	1000	
G - M.20	M.20x1000	1000	
G - M.22	M.22x1000	1000	
G - M.24	M.24x1000	1000	
G - M.27	M.27x1000	1000	
G - M.30	M.30x1000	1000	

**YAYLI RONDELA / CONIC WASHER DIN 127 A2 304**

Sipariş Kodu Reference No.	Birim (metric)
CW - M.3	M.3
CW - M.4	M.4
CW - M.5	M.5
CW - M.6	M.6
CW - M.8	M.8
CW - M.10	M.10
CW - M.12	M.12
CW - M.14	M.14
CW - M.16	M.16
CW - M.18	M.18
CW - M.20	M.20
CW - M.22	M.22
CW - M.24	M.24
CW - M.27	M.27
CW - M.30	M.30

**SAC GÖMLEKLİ DUBEL / DOWEL PLATE LINERS**

Sipariş Kodu Reference No.	Dubel Boyu Dowel Length (mm)	Dubel Dış Çapı Dowel Outside Diameter Ø(mm)	Cıvata Ölçüsü Bolt Size metric (mm)	Emniyetli Çekme Yüğü Safe Tensile Load (kg)
SGD-M6x46	46	8	6	250
SGD-M6x65	65	8	6	350
SGD-M8x55	55	10	8	750
SGD-M8x75	75	10	8	850
SGD-M10x70	70	12	10	1250
SGD-M10x85	85	12	10	1300
SGD-M10x110	110	12	10	1500
SGD-M12x75	75	16	12	2000
SGD-M12x90	90	16	12	2100
SGD-M12x110	110	16	12	2200



Gömlek yapısı her kalite betonda açılma yaparak emniyetli ve güvenli tutunma sağlar. Paslanmalara karşı çinko kaplıdır.

## ÇAKMALI DÜBEL / HAMMERSET DOWEL



Sipariş Kodu Reference No.	Dübel Boyu Dowel Length (mm)	Dübel Dış Çapı Dowel Outside Diameter Ø(mm)	Cıvata Ölçüsü Bolt Size metric (mm)	Emniyetli Çekme Yüğü Safe Tensile Load (kg)
ÇD-M8x25	25	8	6	350
ÇD-M10x30	30	10	8	500
ÇD-M12x40	40	12	10	700
ÇD-M16x50	50	16	12	2000
ÇD-M17x55	55	17	14	2250
ÇD-M20x65	65	20	16	2400
ÇD-M25x80	80	25	20	3250

Dübel içindeki konik pim çakılarak, dengeli açma ve zemini tutma özelliği sağlar. Paslanmalara karşı çinko kaplıdır.

## PLASTİK DÜBEL / PLASTIC DOWEL



Sipariş Kodu Reference No.	Ölçü Dimension Ø(mm) L (mm)	RENK Colour	Malzeme Material
PD-6-B	6 - 30	BEYAZ / GREY	Plastic
PD-7-B	7 - 35	BEYAZ / GREEN	
PD-8-B	8 - 40	BEYAZ / BLUE	
PD-10-B	10 - 45	BEYAZ / RED	
PD-12-B	12 - 60	BEYAZ / WHITE	

## VİDA / SCREW



Sipariş Kodu Reference No.	Ölçü Dimension Ø(mm) L (mm)	Malzeme Material
V - 4,7 X43	4,7 - 43	Steel
V -		
V -		
V -		
V -		

Please specify the sizes

## OPERASYON PLATFORMU / OPERATING PLATFORM

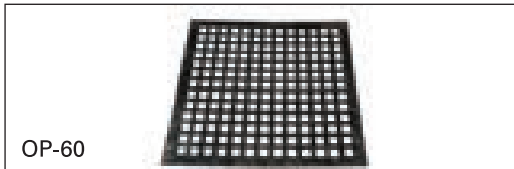

Sipariş Kodu Reference No.	Ebatları Size (mm)	Kalınlık Thickness (mm)	Malzeme Material
OP-60	600X600	5	H.D.G. STEEL

## İSTEĞE BAĞLI ÖZEL İMALATLAR / EXAMPLES OF OPTIONAL APPLICATION



BORU TAŞIYICI ASKI TAKIMI

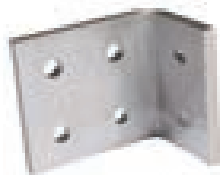

90° BÜKÜMLÜ ALÜM. LAMA



BÜKÜMLÜ ALÜMİNYUM



ÖZEL İMALATLAR

# İLETKENLER

## CONDUCTORS

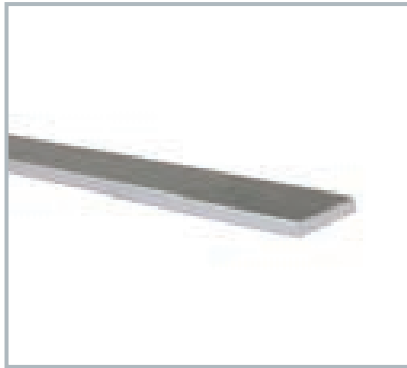
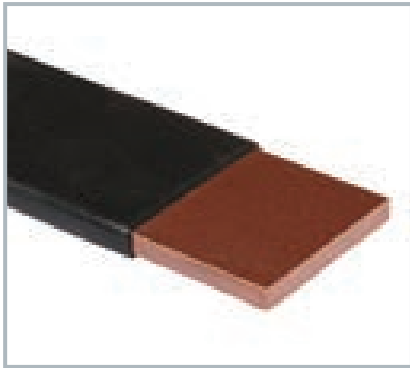
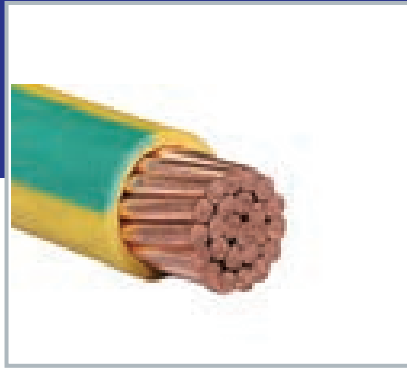
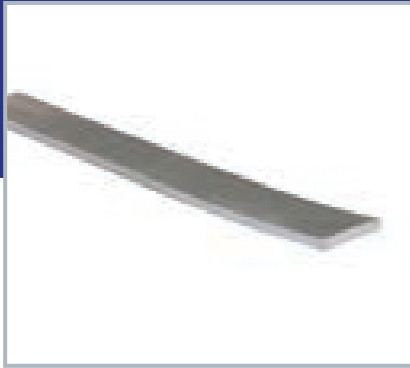

**BİR-ER** ELEKTRİK SİSTEMLERİ YAPIM MÜHENDİSLİK SAN. ve TİC. LTD. ŞTİ.

**TOPRAKLAMA ŞERİDİ GALVANİZLİ LAMA / H.D. GALVANIZED STEEL TAPE CONDUCTORS**



Sipariş Kodu Reference No.	Ebatları Nominal Size (mm)	Ağırlık Weight (kg/m)	Sevk Uzunluğu Delivery Length (m)	Malzeme Material
TŞ-30x3	30x3	0,72	50	H.D.G. Steel
TŞ-30x3,5	30x3,5	0,85	50	
TŞ-30x4	30x4	0,96	50	
TŞ-30x5	30x5	1,20	50	
TŞ-35x3	35x3	0,84	50	
TŞ-40x3	40x3	0,96	50	
TŞ-40x4	40x4	1,28	40	
TŞ-40x5	40x5	1,60	40	
TŞ-50x5	50x5	2,00	30	

H.D.G: Hot Dip Galvanized

**ELEKTROLİTİK BAKIR LAMA / BARE COPPER TAPE CONDUCTORS**



Sipariş Kodu Reference No.	Ebatları Nominal Size (mm)	Ağırlık Weight (kg/m)	Malzeme Material
BL-20x3	20x3	0,534	E-Cu
BL-20x4	20x4	0,712	
BL-20x5	20x5	0,890	
BL-20x10	20x10	1,780	
BL-25x3	25x3	0,667	
BL-25x4	25x4	0,890	
BL-25x5	25x5	1,120	
BL-30x3	30x3	0,804	
BL-30x4	30x4	1,070	
BL-30x5	30x5	1,340	
BL-30x10	30x10	2,670	
BL-40x3	40x3	1,070	
BL-40x4	40x4	1,420	
BL-40x5	40x5	1,780	
BL-40x10	40x10	3,560	
BL-50x3	50x3	1,340	
BL-50x5	50x5	2,230	
BL-50x10	50x10	4,450	
BL-60x4	60x4	2,136	
BL-60x5	60x5	2,670	
BL-60x10	60x10	5,340	
BL-80x5	80x5	3,560	
BL-80x10	80x10	7,120	
BL-100x5	100x5	4,450	
BL-100x10	100x10	8,900	
BL-120x10	120x10	10,700	
BL-150x10	150x10	13,400	
BL-160x10	160x10	14,200	

### KALAY KAPLI BAKIR LAMA / TINNED COPPER TAPE CONDUCTORS

Sipariş Kodu Reference No.	Ebatları Size (mm)	Ağırlık Weight approx.(kg/m)	Malzeme Material
KKBL-20x3	20x3	0,534	E-Cu
KKBL-20x4	20x4	0,712	
KKBL-20x5	20x5	0,890	
KKBL-20x10	20x10	1,780	
KKBL-25x3	25x3	0,667	
KKBL-25x4	25x4	0,890	
KKBL-25x5	25x5	1,120	
KKBL-30x3	30x3	0,804	



### PVC KAPLI BAKIR LAMA / PVC COPPER TAPE CONDUCTORS

Sipariş Kodu Reference No.	Ebatları Size (mm)	Ağırlık Weight approx.(kg/m)	Malzeme Material
PKBL-20x3-B	20x3	0,587	E - COPPER
PKBL-20x4-B	20x4	0,783	
PKBL-20x5-B	20x5	0,979	
PKBL-20x10-B	20x10	1,958	
PKBL-25x3-B	25x3	0,734	
PKBL-25x4-B	25x4	0,979	
PKBL-25x5-B	25x5	1,232	
PKBL-30x3-B	30x3	0,884	

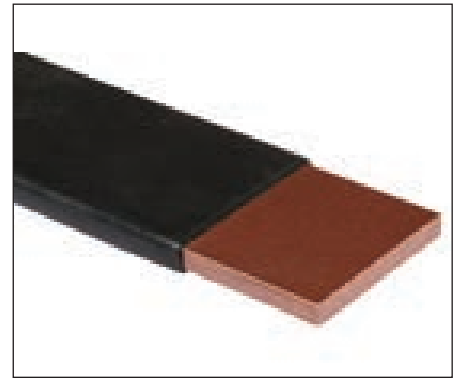

### ALUMİNYUM LAMA / ALUMINIUM TAPE

Sipariş Kodu Reference No.	Ebatları Size (mm)	Ağırlık Weight (kg/m)	Malzeme Material
AL-30x5	30x5	0,41	%99,5 ALUMINIUM
AL-50x5	50x5	0,68	
AL-50x10	50x10	1,35	
AL-80x10	80x10	2,17	
AL-100x10	100x10	2,71	
AL-120x10	120x10	3,25	



### ÇIPLAK ÖRGÜLÜ BAKIR İLETKEN / STRANDED ELECTROLYTIC COPPER CABLE

Sipariş Kodu Reference No.	İletken Kesiti Conductor Range (mm <sup>2</sup> )	Dış Çap (yaklaşık) Outside Diameter approx.(mm)	Net Ağırlık (yaklaşık) Net Weight (approx.) (kg/km)
ÇÖBI-10	10	4	87
ÇÖBI-16	16	5	144
ÇÖBI-25	25	6	224
ÇÖBI-35	35	7	311
ÇÖBI-50	50	8	448
ÇÖBI-70	70	10	611
ÇÖBI-95	95	12	849
ÇÖBI-120	120	14	1065
ÇÖBI-150	150	15	1297
ÇÖBI-185	185	17	1616
ÇÖBI-240	240	19	2138





**PVC İZOLELİ ÖRGÜLÜ BAKIR KABLO / PVC INSULATED STRANDED COPPER CABLE H07V-R 450/750V**

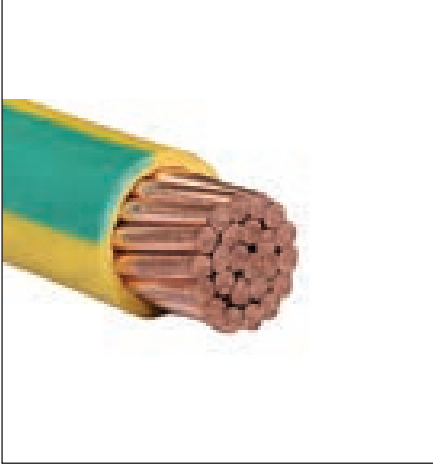

Sipariş Kodu Reference No.	İletken Kesiti Conductor Range (mm <sup>2</sup> )	Dış Çap (yaklaşık) Outside Diameter approx (mm)	Net Ağırlık (yaklaşık) Net Weight (approx.) (kg/km)
İÖBİ-10	10	6	110
İÖBİ-16	16	7.1	171
İÖBİ-25	25	8.4	258
İÖBİ-35	35	9.6	350
İÖBİ-50	50	11.2	479
İÖBİ-70	70	12.6	673
İÖBİ-95	95	15	927
İÖBİ-120	120	17	1160
İÖBİ-150	150	18.2	1429
İÖBİ-185	185	20.3	1800
İÖBİ-240	240	23.6	2311

YELLOW / GREEN PVC COVERED

**KULLANILDIĞI YERLER :** Kapalı, kuru yerlerde, sabit tesislerde, dağıtım panolarında, sıva altı ve sıva üstünde boru içinde kullanılır.

**APPLICATIONS :** Used in covered, dry places, in fixed plants, in distribution panels, on and under plaster as laid in conduit or on insulating support.

**PVC İZOLELİ BAKIR İLETKEN / PVC INSULATED STRANDED COPPER CABLE**



Sipariş Kodu Reference No.	İletken Kesiti Conductor Range (mm <sup>2</sup> )	Dış Çap (yaklaşık) Outside Diameter approx (mm)	Net Ağırlık (yaklaşık) Net Weight (approx.) (kg/km)
PİBİ-10	10	8.1	150
PİBİ-16	16	9,0	209
PİBİ-25	25	10,9	322
PİBİ-35	35	12,2	422
PİBİ-50	50	13,8	555
PİBİ-70	70	15,4	756
PİBİ-95	95	17,7	1035
PİBİ-120	120	19,2	1273
PİBİ-150	150	21,1	1559
PİBİ-185	185	23,3	1936
PİBİ-240	240	26,4	2525

BLACK PVC COVERED

**KULLANILDIĞI YERLER :** Kapalı, kuru yerlerde, sabit tesislerde, dağıtım panolarında, sıva altı ve sıva üstünde boru içinde kullanılır.

**APPLICATIONS :** Used in covered, dry places, in fixed plants, in distribution panels, on and under plaster as laid in conduit or on insulating support.





**BİR-ER** ELEKTRİK SİSTEMLERİ YAPIM MÜHENDİSLİK SAN. ve TİC. LTD. ŞTİ.

**OFFICE :**

Kuzguncuk, İcadiye Cad. No: 72/2  
34674 Üsküdar - İSTANBUL / TURKEY  
Tel : +90 216 492 19 60 (pbx)  
Fax : +90 216 532 30 43  
e-mail : info@birerelektrik.com

**FACTORY :**

DES San. Sitesi 110 Sok. D.25 Blok No:7  
34776 Y.Dudullu - İSTANBUL / TURKEY  
Tel : +90 216 527 42 98 (pbx)  
Fax : +90 216 527 37 28  
e-mail : info@birerelektrik.com

[www.birerelektrik.com](http://www.birerelektrik.com)



EXTERNAL  
PROTECTION



INTERNAL  
PROTECTION



EARTHING



EXOTHERMIC  
WELDING



PREVENTIVE  
PROTECTION

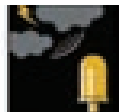

OFFICIAL DISTRIBUTOR FOR TURKEY:

APLIWELD®

**BİR-ER** ELECTRICAL SYSTEMS INSTALLATION ENGINEERING INDUSTRY & TRADING CO. LTD.